

Southwark Council

Ledbury Estate

Structural Assessment of Bromyard,
Peterchurch, Sarnsfield and Skenfrith
House

Issue 2 | 24 November 2017

This report takes into account the particular instructions and requirements of our client.

It is not intended for and should not be relied upon by any third party and no responsibility is undertaken to any third party.

Job number 245112-05

Ove Arup & Partners Ltd
13 Fitzroy Street
London
W1T 4BQ
United Kingdom
www.arup.com

ARUP

Contents

	Page
1	Executive Summary 1
2	Introduction and Brief 2
3	The Buildings 3
3.1	Description of buildings 3
3.2	History of Ledbury Estate and LPS buildings 7
4	Assessment: Phase 1 9
4.1	Cracking/gaps reported 9
4.2	Investigations 10
4.3	Assessment conclusions 14
5	Assessment Phase 2 14
6	Assessment Phase 3 14
6.1	Further investigations 15
6.2	Durability assessment 15
6.3	Disproportionate collapse assessment 15
6.4	Stability/ wind assessment 19
7	Strengthening Measures 23
7.1	Disproportionate collapse 23
7.2	Durability 24
7.3	Wall ties 24
8	References 26

1 Executive Summary

Arup have been appointed by Southwark Council to undertake a structural assessment of the four tower blocks on the Ledbury Estate to assess the resistance to disproportionate collapse, the resistance to wind loading and the durability of the concrete structure.

To do this, intrusive investigations in 19 flats across the four tower blocks have been undertaken, to understand the construction and condition of the buildings.

The findings of the intrusive investigations and structural assessment are as follows:

- The structure of the buildings is in good condition. No significant deterioration has been found of either the concrete or the embedded steel reinforcement;
- The structure of each building meets wind loading requirements as defined by current building codes [13];
- As previously identified, the buildings do not fully comply with the recommendations for the prevention of disproportionate collapse in the 2012 guidance produced by BRE and the Department of Communities and Local Government [2]. This means that an extreme event such as a gas explosion could lead to the collapse of part of the building.

As a result, the following structural strengthening measures are recommended:

- **Disproportionate collapse** – incorporate the measures shown indicatively in Appendix B;
- **Wind resistance** – inspect and if necessary replace the material in the joints around the external wall panels.

Until this strengthening is complete, the following measures to mitigate risks should be undertaken:

- **Disproportionate collapse**
 - turn off the piped gas has now removed the main risk;
 - ban the use of bottled gas and oxygen cylinders.

2 Introduction and Brief

This report describes the structural assessments undertaken by Arup, on behalf of Southwark Council, on the four tower blocks on the Ledbury Estate in Peckham, South London.

The Estate houses four 14-storey precast concrete Large Panel System (LPS) tower blocks. The buildings were built for the Greater London Council by Taylor Woodrow Anglian (TWA) between 1968 and 1970. Southwark Council's asset list records the dates of construction as Bromyard (1968), Sarnsfield (1969), Skenfrith (1969) and Peterchurch House (1970).

The assessments took place in three distinct phases. All three phases are reported here.

Phase 1

In July 2017, Arup was appointed by Southwark Council to carry out a visual investigation into the structure of four tower blocks, after residents reported cracks appearing in the ceilings, floor and walls. This investigation concluded that these cracks were actually gaps between the precast concrete panels and were not a cause for structural concern.

Phase 2

Following the conclusion of the Phase 1 assessment, Arup was commissioned by Southwark Council to assess whether the four tower blocks on the Ledbury Estate were robust enough to withstand a gas explosion without incurring disproportionate collapse.

In the absence of documentation on record specifically relating to the Ledbury Estate, all information for this scope of work had to come from intrusive and visual investigations.

Southwark Council advised that there were two vacant flats immediately available in which exploratory investigations could take place. Given the urgency of assessing the risk from a gas explosion with occupied blocks, the assessment was based on findings from exploratory investigations in the two vacant flats.

On the completion of the intrusive investigations, the performance of the tower blocks in the event of a gas explosion was assessed against the BRE Large Panel System (LPS) Assessment Guide [2] and current building codes.

It was concluded that the buildings were not sufficiently robust to resist a gas explosion without incurring disproportionate collapse, and the decision was made by Southwark Council, in August 2017, to remove piped gas from the four tower blocks on the Ledbury Estate.

Phase 3

Following the conclusion of the Phase 2 assessments, Arup was commissioned by Southwark Council to assess whether, once the piped gas was turned off, there

were any structural strengthening measures required to enhance the margin of safety to the full level expected for this type of building.

The following steps were undertaken as part of the Phase 3 assessment:

1. Further intrusive investigations (in 19 flats across all four blocks) to establish a better overall understanding of the structure. Firstly, by understanding if the details investigated during Phase 2 were consistent in all four blocks. And secondly, investigating the structural details that time constraints during Phase 2 prevented.
2. Selected material testing to understand the concrete durability (i.e. carbonation and chloride tests).
3. Assessment of the resistance against disproportionate collapse, considering all forms of accidental loading other than a gas explosion.
4. Assessment of the resistance against wind loading.
5. Conceptual design of the structural strengthening and remedial works, to enhance the margin of safety to the full level expected for this type of building

3 The Buildings

3.1 Description of buildings

There are four tower blocks on the Ledbury Estate; Bromyard House, Peterchurch House, Sarnsfield House and Skenfrith House, each 14 storeys high, with a floor to floor height of approximately 2.7m (Figure 1). Each has a 'H-shaped' floorplan, with two pairs of flats on each floor separated by a lift and stair core at the centre. Skenfrith and Peterchurch House have one and three bedroom flats throughout the block. Sarnsfield and Bromyard House have one and three bedroom flats up to level 4, above which there are two bedroom flats. Floorplans vary slightly between one, two and three bedroom flats, see Figure 2.



Figure 1 Peterchurch House

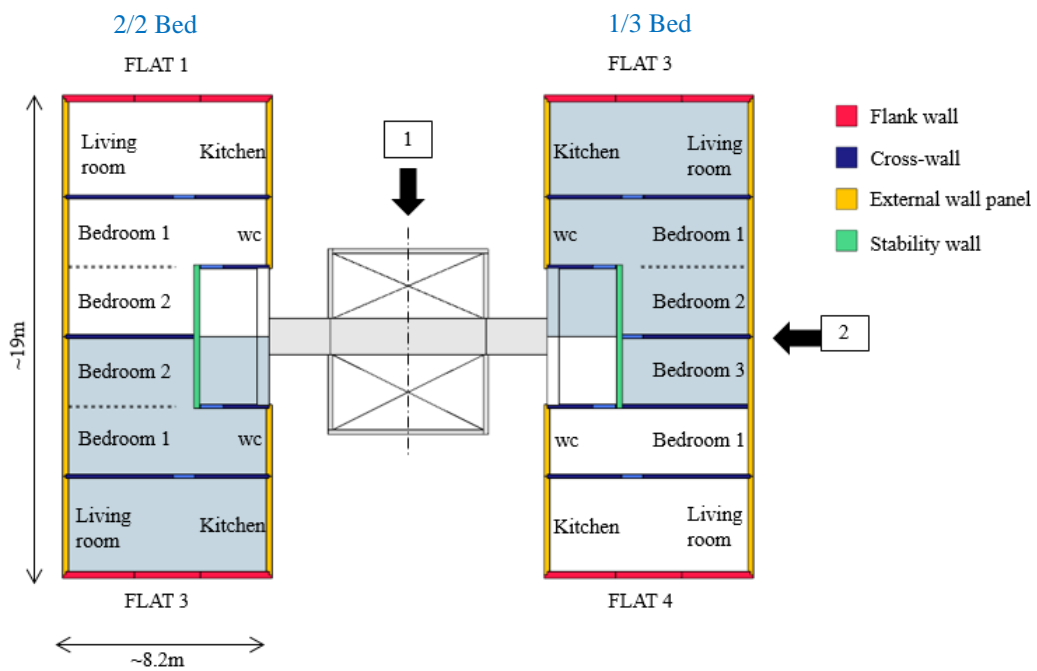

Figure 2 Approximate floorplan of the Ledbury Estate tower blocks. For illustrative purposes a one and three bedroom flat layout is shown on the same floor as a two-bedroom flat layout.

3.1.1 Structural form

Residential blocks

The tower blocks were constructed using a precast concrete Large Panel System (LPS), where the panels were built in factories and assembled on site. The floor slabs generally span one-way onto the internal cross-walls and the outer flank walls, except for the slabs adjacent to the stability wall, which also bear onto this wall.

The external wall panels are stacked upon each other and are connected back to the floor slabs via structural steel straps or looped bars.

The approximate floor plan of one residential block (considering both a pair of two-bedroom flats and a pair of one and three bedroom flats) can be seen in Figure 3. Floor slab panels are coloured according to their span-size.

There are additional thin concrete walls supported by floorslabs at each level which are considered not to be part of the main building structure.

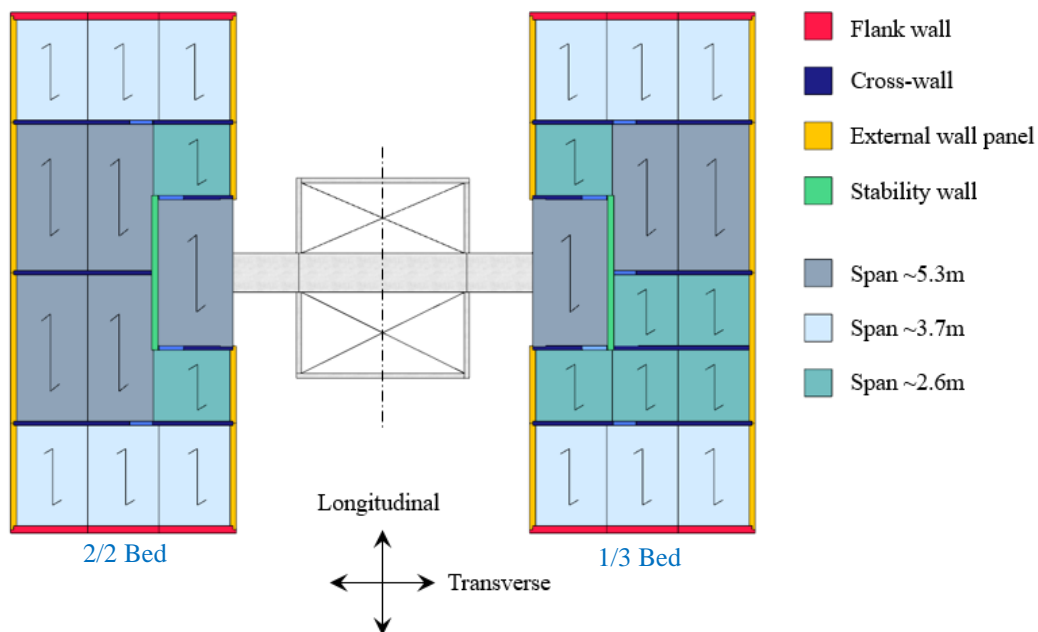

Figure 3 Approximate floorplan of the Ledbury Estate tower blocks, illustrating the clear span dimensions. For illustrative purposes, a one and three bedroom flat layout is shown on the same floor as a two-bedroom flat layout.

Lift and stair core

The lift/stair area is comprised of three different wall panel types, which are stacked upon each other and bolted together at the corners, see Figure 4. All wall panels are approximately 185mm thick and 2.7m high.

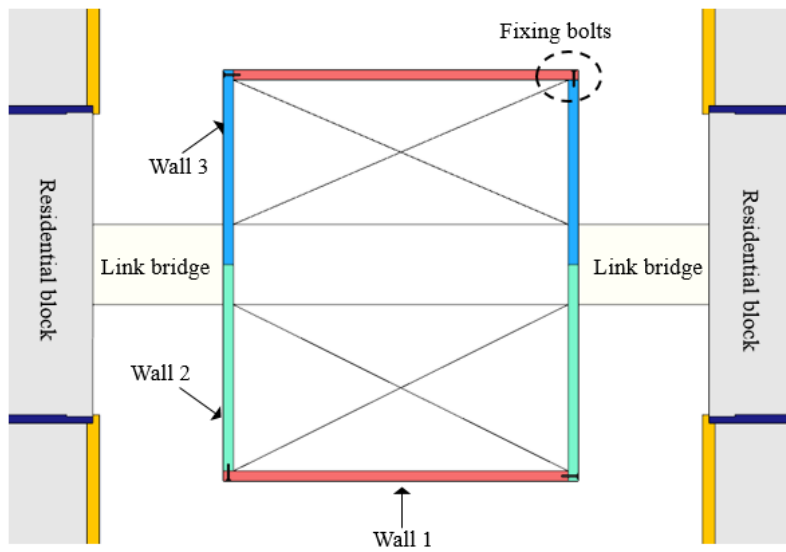

Figure 4 Lift/stair area comprised of three different wall panel types, which are bolted together at the corners

Wall types 2 and 3 are connected at the centre of the link bridge via a reinforced coupling beam. The coupling beams extend from the wall panels on either side and form a bearing joint at the centre, see Figure 5.

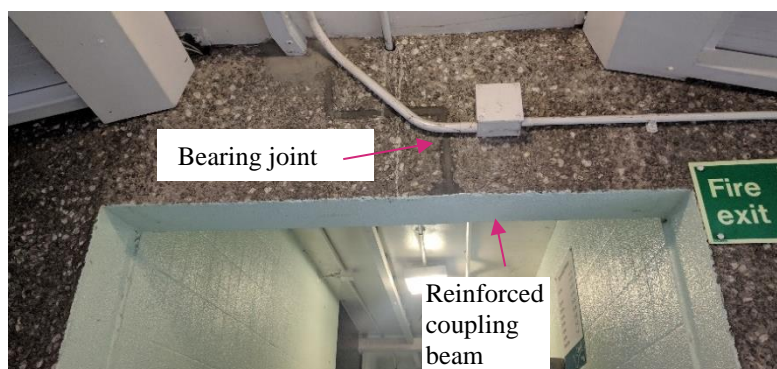
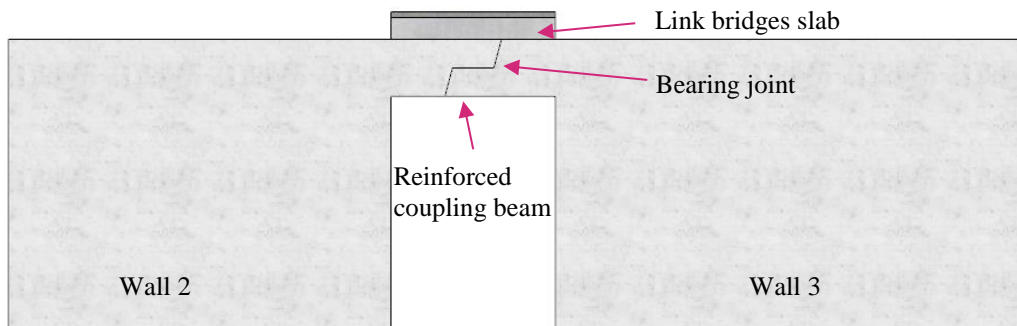

Figure 5 Lift/stair core walls are connected via a coupling beam with a bearing joint at the centre. Sketch of the wall panels (above), photograph of the bearing joint (below)

3.2 History of Ledbury Estate and LPS buildings

Ledbury Estate

Ledbury Estate was originally commissioned by the Greater London Council (GLC) in the 1960s and transferred over to Southwark Council in the 1980s following the dissolution of the GLC. Unfortunately, a great deal of information was lost during this transition process.

The buildings were built by Taylor Woodrow Anglian (TWA) between 1968 and 1970. Southwark Council's asset list records the construction dates as Bromyard House (1968), Sarnsfield House (1969), Skenfrith House (1969) and Peterchurch House (1970).

The Large Panel System used is also known as the Larsen-Nielsen design.

It is understood that the Ledbury Estate was formally known as Camelot Street and also Commercial Way.

The following sources were thoroughly searched for any information related to Ledbury Estate:

- Southwark Council archives
- London Metropolitan archives
- British Research Establishment (BRE) archives
- Taylor Woodrow archives

There was no information from the Southwark Council archives, British Research Establishment (BRE) archives or the Taylor Woodrow archives. A limited number of planning and architectural drawings, showing only basic building outlines, but no technical details, were located at the London Metropolitan archives, as were receipts for a total of £53,700 "remedial" works between 1968-1969 which would have been during the period of construction and following the collapse at Ronan Point. However, no details or description of what "remedial" works were carried out exists.

A note was also located which listed four blocks at 'Camelot Street' as under construction (in 1968) of which the design was being modified to comply with circular 62/68. However, no details of these modifications are available.

No construction drawings were located.

Ronan Point partially collapses

In May 1968, Ronan Point tower block, built by Taylor Woodrow using their 'Anglian system', suffered a partial collapse as a result of a gas explosion. The damage caused by the gas explosion was considered to be more extensive (causing more parts of the building structure to collapse) than should have occurred following an explosion of that magnitude. This led to the reappraisal of Large Panel System blocks throughout the UK. The Ministry of Housing and Local Government issued Circulars 62/68 [4] and 71/68 [5] in response.

Circular 62/68 issued

Circular 62/68 required that all LPS blocks over six storeys in height were to be appraised by a structural engineer and their ability to withstand a force equivalent to a static pressure of 34kPa without incurring disproportionate collapse be assessed. If this requirement was not met, the blocks were to be strengthened or gas removed. Additionally, all new LPS blocks were to be built to these same standards.

Circular 62/68 also stated that the current wind code “CP3 Chapter V 1952” was out-dated and recommended that all LPS blocks over six storeys be assessed in relation to their resistance to wind. It was recommended that until a revised wind code was available, designers should take note of current research papers [6][7].

Circular 71/68 issued

Circular 71/68 maintained that LPS blocks with piped gas should be assessed against a pressure of 34kPa, however if removed, this figure could be reduced to 17kPa.

Amendment to building regulations

Minimum requirements for preventing disproportionate collapse in any buildings of five or more storeys were also introduced at this time, outlined in an Amendment to the Building Regulations in 1970 [8]. Subsequent revisions to structural codes and replacement codes have since incorporated the principle of robustness and avoiding disproportionate collapse, in general by providing effective horizontal and vertical ties. Requirement A3 in the current building regulations “*The building shall be constructed so that in the event of an accident the building will not suffer collapse to an extent disproportionate to the cause*” applies to all new buildings, however buildings are now placed into classes and additional measures in relation to the prevention of disproportionate collapse apply to the higher classes. The higher the class, the more stringent the rules [3].

Amendment to wind codes

CP3 Chapter V 1972 introduced significant changes to the national wind code in the UK. Basic wind pressures used for design increased and wind suction had to be accounted for. Current codes of practice for UK building design (BS EN 1991-1-4) give similar pressures to CP3 Chapter V 1972.

BRE research on LPS blocks

BRE also published a number of reports following the partial collapse of Ronan Point, including a report in 1985 [1], which specifically reviewed the Taylor Woodrow Anglian form of construction; Ledbury Estate was referenced in this report. This report states the tower blocks on the Ledbury Estate (unlike Ronan Point) used a Type B H2 flank wall joint which were “*designed to resist forces equivalent to a standard static pressure of 5lbf/in² [34kPa]*”.

In relation to the flank wall to slab H2 joints in 'Type B' buildings, the report stated the following “*the in-situ flank wall joints are much bigger, contain interlocking reinforcement connecting the units and vibrated concrete was*

specified and practical. Such joints will accept eccentric loading and are less sensitive to any deficiencies which may exist in the hand-packed joints, providing that the in-situ concrete is confirmed to be solid. The condition of the joints should be checked.”

However, this report provides no drawings of the Type B H2 joint nor any evidence that the Ledbury Estate was assessed on an individual basis.

BRE guidance on assessing LPS blocks

In 2012 BRE published the “Handbook for the structural appraisal of Large Panel System (LPS) dwelling blocks for accidental loads” [2]. This document was written in order to update the Government’s 1968 guidance to take into account all of BRE’s subsequent research, the general development of assessment methodologies and to align with current structural design codes. The document continues to recommend assessing LPS blocks with piped gas for a pressure of 34kPa, or 17kPa for blocks without piped gas.

This document is considered the current best practice guidance for the appraisal of Large Panel System buildings.

4 Assessment: Phase 1

In July 2017 Arup was commissioned by Southwark Council to assess the structural implications of the cracking/gaps reported by the residents of the four tower blocks on the Ledbury Estate; Bromyard House, Peterchurch House, Sarnsfield House and Skenfrith House. The key points addressed were;

- What is the cause of the cracks/gaps?
- Do these cracks/gaps pose a structural risk?

4.1 Cracking/gaps reported

‘Cracks’ up to 30mm wide reported were reported by both residents and surveyors. Crack patterns are repeated throughout the tower blocks with the largest cracks always occurring in the same position (between the external wall panels and intermediate cross-wall separating the two bedrooms, location 1, Figure 6.

Three main crack/gap types which occur are:

1. Gaps between the external wall panels and internal walls and floors, location 1, Figure 6
2. Gaps between adjoining precast concrete panels, location 2, Figure 6
3. Gaps between the precast staircase landings and the external stairwell walls, locations 3, Figure 6

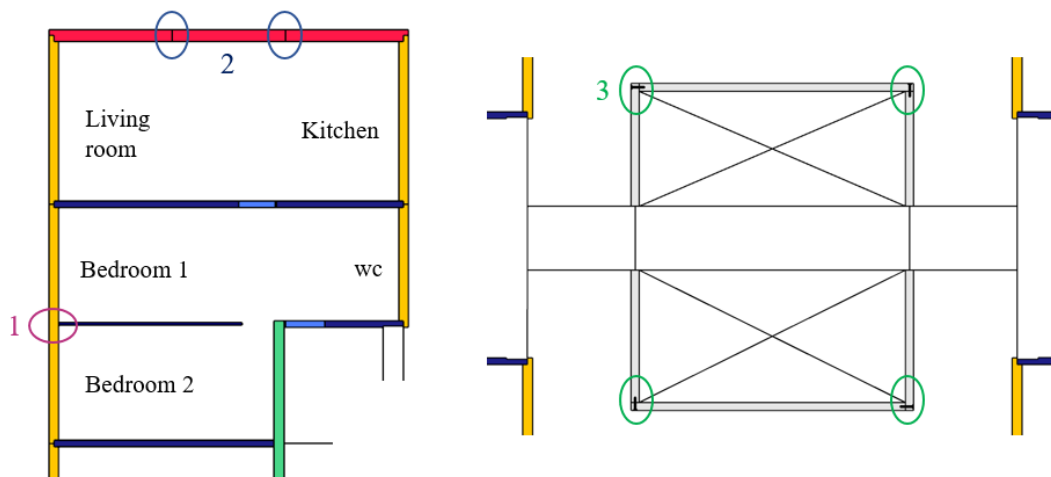

Figure 6 Approximate floor-plan of a two-bedroom flat; locations of the primary ‘cracks’ reported are marked (LHS). Approximate floor-plan of the lift and stair core, showing the locations of the primary ‘cracks’ reported (RHS)

4.2 Investigations

In the absence of any construction drawings, all structural information in relation to the Ledbury Estate tower blocks, used in this report, has come from visual and intrusive investigations completed as part of this scope of work.

Arup engineers visited a total of six flats and reviewed the records of ‘cracks’ provided by Southwark Council surveyors, whom at the time had visited approximately 70% of the residences. A limited number of intrusive investigations took place in a void flat in Skenfrith House and on the outside of Sarnsfield and Peterchurch Houses on 3 and 4 July 2017. The purpose of these intrusive investigations was to investigate the form and condition of 1) the fixings which tie the external wall panels back to the slabs and 2) the fixings which tie the wall panels of the lift and stair cores together. A visual inspection of the exterior of all four tower blocks was also undertaken from ground level.

4.2.1 Crack/gap type 1: Gaps between the external wall panels and internal walls and floors

Description:

Throughout the four tower blocks, floor to ceiling vertical gaps exist between the external wall panels and internal walls separating the bedrooms in the two and three bedroom flats, as well as horizontal gaps between the external wall panels and floor slabs.

Cause of crack/gap:

Differential drying shrinkage led to curvature of the panels, which is likely to have happened in the first one to two years after construction. And because the panels are effectively only secured at the corners (by two fixings at each panel end at floor level and by the external wall panel above at ceiling level), this allows

gaps to form over the full storey height between the centre of the bowed panel and intermediate cross-walls. Horizontal gaps also form between the external wall panels and the floor slabs. Additionally, temperature changes cause the gaps to further open/close, see Figure 7.

This is consistent with what has been reported by residents (gaps have been present for 17+ years and open and close depending on weather conditions) and is also consistent with gaps reported between the external wall panels and the internal walls in the 1985 BRE report [1].

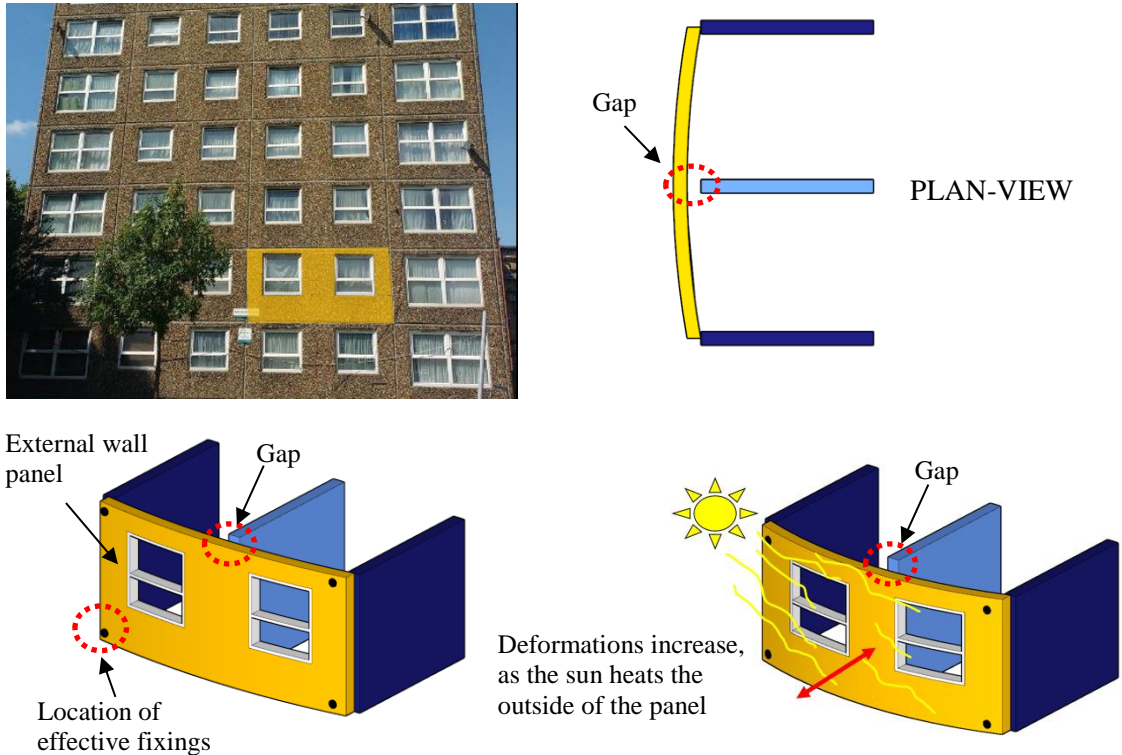

Figure 7 Floor to ceiling vertical gap between the intermediate cross-walls and the external wall panels

Investigations

Fixings tying together the external wall panels and slabs were exposed (from the outside and inside) and were found to be in very good condition, with no evidence of corrosion.

4.2.2 Crack/gap type 2

Description

Cracks occur in the internal finishes (plaster/paint) where two precast concrete panels meet e.g. at location 2, Figure 6. An example of this can be seen in Figure 8.

Cause

All buildings move slightly due to thermal movements and wind. The building is made from large panels, made in a factory, small movements between those panels is to be expected.

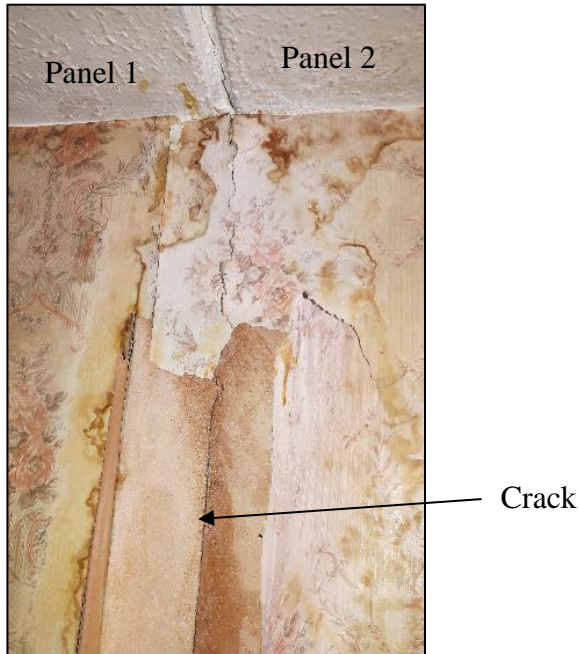

Figure 8 Cracks occur in the internal finishes (plaster/ paint) where two precast concrete panels meet

4.2.3 Crack/gap type 3

Description

Gaps have opened up at the corner of the stairwell where two panels meet, see Figure 9. The horizontal gaps between the staircase landings and the walls is typically 5-6mm.

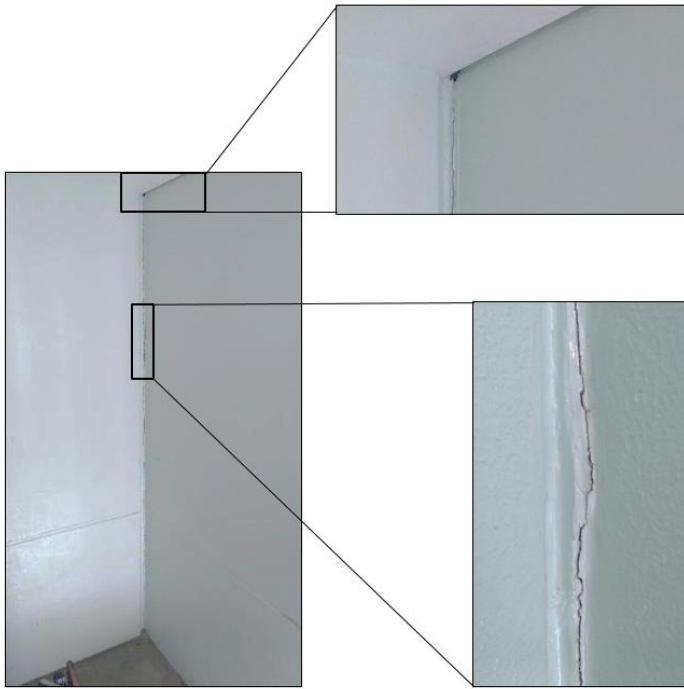

Figure 9 Gaps between adjacent wall panels in the lift and stair cores

Cause

The fixings which hold the walls together sit in a slightly oversized holes, by 5-6mm, therefore allowing movement between the panels.

Investigations

Three of the fixings bolts were exposed by breaking away the surrounding concrete, see Figure 10. These were exposed on Bromyard, Sarnsfield and Peterchurch House.

Stainless steel bolts, 34mm in diameter, sitting in slightly oversized holes (by 5-6mm) were exposed. The fixings and the surrounding reinforcement cage were found to be in very good condition, with no evidence of corrosion.



Figure 10 Fixings bolts are concealed behind black sealant (LHS). Fixing bolt exposed by breaking away surrounding concrete (RHS)

4.3 Assessment conclusions

The causes of the cracks/gaps reported by residents are understood, and because none of the gaps that were found are between load-bearing elements, none of the gaps pose any structural concerns about the building as a whole.

5 Assessment Phase 2

Following the conclusion of the Phase 1 assessment, Arup was commissioned by Southwark Council to assess whether the four tower blocks on the Ledbury Estate were robust enough to withstand a gas explosion without incurring disproportionate collapse. The performance of the blocks was assessed against the BRE Large Panel System (LPS) Assessment Guide and current building codes.

This assessment (an extract from the report originally issued in August 2017 [17]) can be found in Appendix A.

It was concluded based on the information available, obtained from intrusive investigations in two vacant flats, that the buildings were not sufficiently robust to resist a gas explosion without incurring disproportionate collapse. As such, the decision was immediately made by Southwark Council, in August 2017, to remove piped gas from the Ledbury Estate tower blocks, thereby mitigating the main risk of disproportionate collapse.

6 Assessment Phase 3

Following the conclusion of the Phase 2 assessments, Arup immediately began to assess whether, once the piped gas was turned off, there were any structural strengthening measures required to enhance the margin of safety to the full level expected for this type of building. For buildings of this type, the main risk of accidental damage is damage caused by a gas explosion. However, regulations require structural elements in buildings to be able to withstand additional loads, at a certain level beyond the loads the building will experience in its everyday circumstances, even if there is no gas in the building. This provides an additional degree of comfort, such as if there is some other type of accident that damages the building. In addition, the overall performance and condition of the buildings was assessed.

The following steps were undertaken as part of the Phase 3 assessment:

1. Further intrusive investigations to establish a better overall understanding on the structure
2. Material testing to understand the concrete durability
3. Assessment of resistance against disproportionate collapse, considering all forms of accidental loading other than a gas explosion
4. Assessment of resistance against wind loading

5. Conceptual design of the structural strengthening and remedial works, to enhance the margin of safety to the full level expected for this type of building.

6.1 Further investigations

Intrusive investigations took place over a total of 15 days between September and October 2017. The investigations were undertaken by concrete investigation specialists Martech [9], in the presence of an Arup engineer.

The investigations took place in a total of 19 vacant flats across the four tower blocks; seven in Bromyard House, three in Skenfrith House, four in Sarnsfield House and five in Peterchurch House. The sample of flats investigated included one, two and three bedroom flats, with the floor levels ranging from the ground floor to level 13 (the topmost level). A number of communal areas were also investigated, including the lift and stair cores and the link bridges which connect the lift and stair cores to the residential blocks.

The purpose of these investigations was to provide a clearer picture of how the blocks are constructed. While Phase 2 concentrated on the key elements concerning the risk of disproportionate collapse, the Phase 3 investigations were used to understand the overall performance of the blocks including resistance to wind and durability as well as a more in-depth study of the risk of disproportionate collapse in the event of an accidental load. Additionally, the consistency of construction details across the four individual blocks was investigated, to understand if there were significant variations between them which might influence their structural behaviour. The few variations in details that were identified were found to be structurally insignificant.

The durability of the reinforced concrete structure was also investigated.

6.2 Durability assessment

Carbonation and chloride levels in the concrete were tested at several internal locations across the four blocks. High chloride and carbonation levels in reinforced concrete can lead to the corrosion of reinforcement, therefore reducing the strength of the structure.

However, in all cases, the levels measured on the Ledbury Estate were found to be extremely low and are therefore not a concern.

All reinforcement exposed during the internal investigation works appeared to be in good condition with no signs of corrosion.

6.3 Disproportionate collapse assessment

With piped gas removed from the blocks, the main risk of disproportionate collapse has been mitigated, however all forms of accidental loads must be considered. As defined by BRE [2], for LPS blocks, these may include:

- Bottled gas/ Oxygen cylinder explosion

- Vehicle impact
- Fire
- Poor workmanship (none found to date)
- Corrosion of fixings
- Heavy loads on floors or unauthorised structural modifications
- Exceptionally strong winds
- Landslip due to nearby excavations

6.3.1 Disproportionate collapse assessment criteria

The BRE document “Handbook for the structural appraisal of Large Panel System (LPS) dwelling blocks for accidental loads” [2] clearly defines three criteria for the assessment. If the building can be proven to satisfy any one of the three criteria, then it is considered to satisfy requirement A3 of the Building Regulations [10] (which is the requirement to avoid disproportionate collapse) in accordance with Approved Document A [3]. The following is an extract from the BRE assessment guide:

An LPS dwelling block exceeding four storeys in height (i.e. five storeys or higher) will be considered to satisfy Requirement A3 of the Building Regulations if it meets one of the following criteria:

LPS Criterion 1: There is adequate provision of horizontal and vertical ties to comply with the current requirements for Class 2b buildings as set down in the codes and standards quoted in Approved Document A – Structure as meeting the requirements set down in the Building Regulations.

LPS Criterion 2: An adequate collapse resistance can be demonstrated for the foreseeable accidental loads and actions [which is defined as 34kPa for a block with piped gas or 17kPa for a block without piped gas]

LPS Criterion 3: Alternative paths of support that can be mobilised to carry the load, assuming the removal of a critical section of the load bearing wall in the manner defined for Class 2B buildings in Approved Document A – Structure or alternatively assuming the removal of adjacent floor slabs (taking the floor slabs bearing on one side wall at a time) providing lateral stability to the critical section of the load bearing wall being considered.

6.3.2 Assessment discussion

LPS Criterion 1

LPS criterion 1 is a prescriptive approach which defines design loads for the horizontal and vertical connections, or ties, between the structural elements in the buildings.

The different ties are categorised as follows:

- Internal ties, which connect floor slab units to each other across the majority of the floor plate
- Peripheral ties, which connect floor slab units to each other around the edges of the floor plate
- Vertical ties, which connect wall units to each other
- Horizontal ties, which connect floor units to wall units
- Anchorage, which is also concerned with the connections of floor units to wall units, but for which the design load is less onerous than for horizontal ties

The form and condition of these ties were investigated in multiple locations across all four blocks during the Phase 2 and Phase 3 intrusive investigations.

The following table summarises whether the connections exposed during the structural investigations satisfy the above prescriptive requirements:

Item	Is the LPS Criterion 1 satisfied?	Primary reason for the requirement not being satisfied
Internal ties	No	The reinforcement bars within the floor to wall joints do not have sufficient capacity
Peripheral ties	No	There is no continuous or lapped rebar around the periphery of the floor plate
Vertical ties	No	There is no rebar connecting the cross-walls to each other or the external wall panels to each other

Table 1 Assessment of existing building against LPS Criterion 1

LPS Criterion 2

In the absence of piped gas, key structural elements must be assessed for a collapse resistance against a pressure of 17kPa.

Definition (according to BRE [2]): *Collapse resistance is a measure of the ability of a structural system to resist the effects of specified accidental loads or actions occurring at or below a defined threshold.*

The overpressure should be applied simultaneously to all surfaces of a single room/bounding enclosure.

The structural assessment against this criterion is concerned with the resistances of the panels themselves against this defined pressure, as well as the connections between the panels. The form and condition of the panels and ties were investigated in multiple locations across all four blocks during the Phase 2 and Phase 3 intrusive investigations.

The following table summarises whether the structural elements within the building and the connections of these elements to each other satisfy these requirements:

Item	Is the LPS Criterion 2 satisfied?	Primary reason for the requirement not being satisfied
Floor units	No	Insufficient reinforcement in the floor units
Flank walls	No	The flank walls are restrained horizontally by the floor slabs. They can resist 17kPa provided that all of the floor slabs remain present. However, if the floor units do not all remain present, the flank walls cannot resist 17kPa
Cross-walls: Level 8 upwards	No	No reinforcement in the cross-wall panels, together with lower vertical load from the structure above, means the cross-walls cannot develop sufficient arching resistance
Cross-walls: party walls from ground to level 4, Bromyard House and Sarnsfield House	No	Insufficient vertical load from the structure above the cross-walls at the higher levels so arching resistance cannot be developed, and also no reinforcement in the cross-wall panels
Cross-walls: remainder	Yes	

Table 2 Assessment of existing building against LPS Criterion 2

LPS Criterion 3

The third criterion considers whether or not alternative load paths could be mobilised in the event of notional removal of structural elements.

For the purposes of this assessment, the size of the element being removed is defined as a whole precast unit, or a wall of length $2.25H$ where H is the storey height, whichever is smaller. The largest individual precast wall units are the cross-walls adjacent to bedrooms which are approximately 5.4m long.

Owing to the structural arrangement of the building, together with the paucity of reinforcement which could be included in any justification of alternative load paths, it is not possible to find reliable alternative load paths for the existing floor loads.

6.3.3 Disproportionate collapse assessment summary

The existing buildings have been assessed against three separate design criteria, applicable to LPS buildings without piped gas.

The assessment shows that there is some resistance to disproportionate collapse but that the building structure does not fully satisfy the requirements in all respects.

Section 7.1 discusses structural strengthening measures that could be adopted to allow the buildings to satisfy the requirements.

6.4 Stability/ wind assessment

The buildings have been assessed for their resistance to overall lateral loads. The main source of lateral loads on tall buildings in the UK is from wind.

6.4.1 Loading

Wind pressures acting on the tower blocks were calculated using the current wind code [13]. These pressures vary according to the direction of the wind being considered.

In addition to wind pressures, the current concrete code [14] also specifies horizontal forces resulting from geometric imperfections (i.e. the out-of-plumbness of the structure), equal to a small proportion of the permanent dead vertical load, must be considered to act simultaneously in the same direction. The code recommends a standard value for design purposes of 0.0025 of the permanent dead load, which is consistent with normal construction tolerances. A survey to measure the actual out-of-plumbness of the tower blocks on the Ledbury Estate was carried out by Warner Surveys [16] which shows that the buildings are 'more plumb' than the code allowances and so in the assessment this design load has been reduced accordingly.

6.4.2 Resistance to lateral load

Wind pressures are applied to the external walls panels. As the external walls are connected to each floor, the wind load will then travel through the floor plate until it reaches stiff elements within the building which resist these lateral loads. The stiffest elements in these buildings are the loadbearing concrete walls that are aligned with the direction of load, and that are connected to the main structure without joints that can allow movement.

For the purposes of lateral stability, the tower blocks are conservatively considered as three separate structures, see Figure 11. This is because the link bridges have tensile connections in the form of steel straps on each floor to the residential blocks, but they are not connected with tensile connections to the central core.

Thus, wind load acting on the core is resisted only by elements in the core, and wind load on the link bridges and residential block is resisted by elements in the residential blocks.

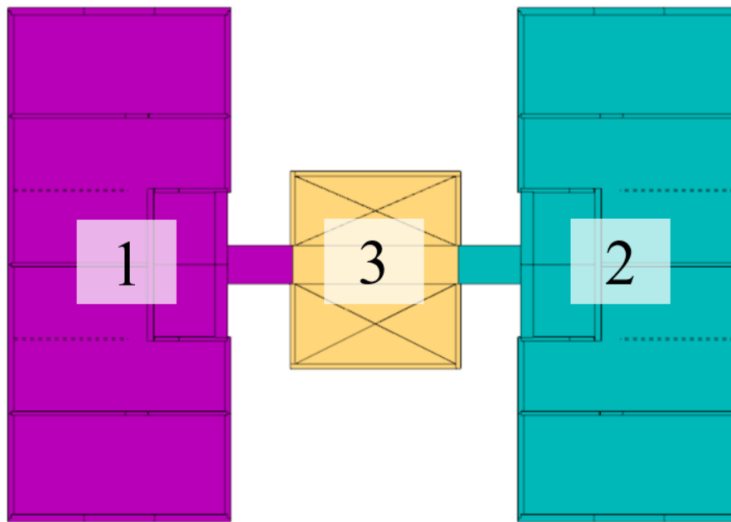

Figure 11 The tower blocks can be considered as three separate buildings; the residential blocks together with the link bridges and the lift/stair core alone

6.4.3 Lift/stair core

The lateral stability resistance of the lift and stair cores is provided by the perimeter walls. The wall panels are connected to each other with bolted connections at the four corners (see Figure 10) and at the beam half-joints above the doors (see Figure 5).

These walls and the connections have been found to provide adequate resistance to lateral loads in all directions acting on the core.

6.4.4 Residential blocks

The two most onerous wind load cases on the residential blocks were considered - the wind perpendicular to the face of each residential block, see Figure 12.

6.4.4.1 West-East direction

This direction aligns the wind load with the loadbearing flank walls and cross-walls, and these elements provide adequate resistance to wind load in this direction.

6.4.4.2 South-North direction

In this direction, the wind load is aligned with one internal loadbearing wall: the stability wall indicated in Figure 12. It is also aligned with the external wall panels and the non-loadbearing internal concrete walls to the bathrooms and between the kitchens and living rooms.

All of these walls were analysed to assess which were the stiffest, because if all elements in the building are connected together without movement joints in the direction of the wind, the stiffer walls will tend to attract proportionately more of the wind load. This means that for the resistance of lateral loads, in general the stiffer walls also need to be the strongest.

The stiffness and the strength resistance that can actually be developed at the assessed lateral load in each wall panel depends on a number of factors:

- the shape of the panel (and whether the panel is solid or has openings)
- the amount of vertical load coexisting with the wind load (from the self-weight of the wall itself together with any floor panels supported by the panel)
- the amount of reinforcement in the wall panel, and between panels
- the stiffness and strength of the connections between the wall panels and the rest of the building, because if this connection allows lateral movement or is insufficiently strong, then the lateral loads cannot get into the panel
- the stiffness and strength of the connections from wall panel to wall panel

A summary of the above factors and how they apply to the walls in this direction is given in the following table:

Item	Stability wall	External wall panels	Internal non-loadbearing panels
Shape	Solid concrete (except for recesses for fuse boxes)	Vary in length and have openings for windows	Thin (typically 63mm thick), relatively short and contain many openings for doors etc
Vertical load	May carry some vertical load from adjacent floor slabs via the narrow continuous bearing on both sides of the wall, although mostly the floor slab is assumed to be spanning onto the cross-walls	Carry their own self weight only	Assumed to be supported at each storey on the floor slabs
Reinforcement	Continuous coupled tensile reinforcing bars at each end of the wall	No tensile connections between panels, and nominal or no reinforcement in the panel	Unreinforced

Stiffness/strength of connection between wall and rest of building	High stiffness connections from floor panel in-plane to wall panel	Steel brackets to the floor plate, a stiff bearing connection to the ends of the cross-walls via the continuously grouted vertical joint, but no horizontal in-plane tensile connection between wall panels	Depends on friction
Stiffness and strength of connection from wall to wall	High stiffness connections from stability wall panel to stability wall panel	Variable dry-pack in the horizontal joints between wall panels	Not connected to each other

Table 3 Stability assessment

The analysis showed that:

- the contribution of the internal non-load bearing walls to overall building stability is negligible
- the connections of floor plate to the external walls panels (indirectly via the cross-walls) are stiff enough to transfer horizontal loads into the external walls
- the stability wall alone is not stiff nor strong enough to resist all of the wind load in this direction
- the external wall panels will attract some lateral load, and therefore must resist it alongside the stability walls

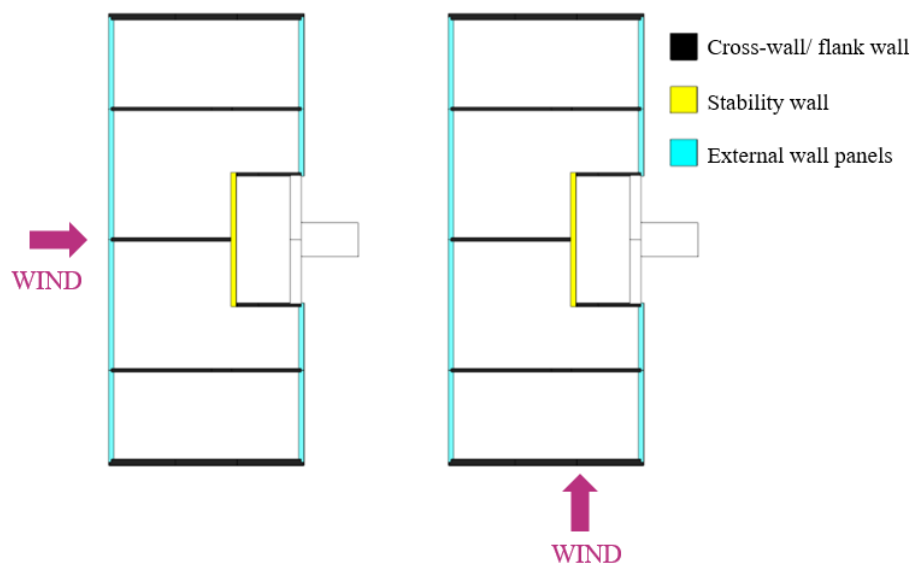

Figure 12 Wind loading perpendicular to each building face of the residential block was considered

6.4.5 Stability/ wind assessment conclusions

The assessment indicates an adequate strength resistance considering the stiffness and strength contribution to lateral stability from the external wall panel and the internal stability wall.

This strength resistance relies on a significant contribution from the external wall panels. Because the reliability of this load path is contingent on the quality of the horizontal joints between these wall panels and the vertical joints at the ends of the panels, it is recommended that every such joint is inspected and repaired by replacing the material in the joints with good quality non-shrink grout and dry-pack in order to secure this load path for the long term.

7 Strengthening Measures

7.1 Disproportionate collapse

With gas supply turned off from the blocks the immediate and main risk of disproportionate collapse has been removed.

However, to provide the buildings with sufficient resistance against disproportionate collapse, to meet current codified recommendations and best practice, structural strengthening measures are required.

The design strategy for the strengthening works is to satisfy a combination of LPS criteria 2 and 3 (see Section 6.3.2). In other words, if a structural element does not satisfy criterion 3, then the purpose of strengthening works is either to provide alternative load paths or to enhance the element strength to resist 17kPa directly such that alternative load paths are not needed.

Many of the strengthening measures to the concrete walls and floors will require local removal and reinstatement of plaster finishes, floor finishes and floor screeds, heating pipes, radiators, sanitary ware including baths and kitchens.

A summary of the strengthening works is provided in the table below.

Item	Reason for strengthening	Purpose of strengthening
Floor units adjacent to flank walls and external wall panels	Flank walls and external wall panels become destabilised without restraint at every floor	Floor units strengthened to provide 17kPa resistance
Cross-walls: Level 8 upwards	Insufficient resistance to 17kPa pressure acting horizontally (the walls with less vertical load in them have lower resistance)	Wall units strengthened to provide 17kPa resistance

	to 17kPa horizontal pressure)	
Cross-walls: party walls from ground to level 4, Bromyard House and Sarnsfield House	Insufficient resistance to 17kPa pressure acting horizontally (the walls with less vertical load in them have lower resistance to 17kPa horizontal pressure - these particular walls discontinue from Level 5 above as the floor layout changes)	Wall units strengthened to provide 17kPa resistance
External wall panels restraints	Existing brackets cannot resist a 17kPa pressure on the external wall panels	Provide additional brackets to the slabs and walls at the panel ends to resist 17kPa on the external wall panels

Table 4 Strengthening works

Sketches outlining these remedial works, and where they are applicable can be seen in Appendix B. These sketches are for Southwark Council to use for high level costing and to be as a basis for detailed design.

The sketches indicate strengthening to the majority of the floors, to all of the external wall panels, and to all internal walls (including party walls) in the top six storeys on all buildings, as well as internal strengthening of the party wall between all one- and three-bedroom flats from ground to level 4 in Bromyard House and Sarnsfield House.

In the short-term, the use of bottled gas and oxygen cylinders should be banned.

7.2 Durability

A maintenance plan which includes proposed future assessment and inspection regimes should be formulated. BRE outlines proposed maintenance measures in the *Handbook for the Structural Assessment of Existing Large Panel (LPS) dwelling Blocks* [2].

7.3 Wall ties

It is recommended that wall ties, to tie the inner and outer leaves of the external wall panels together are provided. This applies to all of the flank walls and external wall panels on all four tower blocks.

It is assumed that stainless steel or galvanized steel wall ties do currently exist [15]. However, inspection to determine the number, location and condition of ties is extremely difficult. Additionally, BRE in their 1985 report on TWA Anglian buildings recommend that additional ties should be provided on the basis that they

may have suffered from fatigue, due to the stresses induced by wind and thermal effects and no amount of sampling can eliminate this risk [1].

8 References

- [1] The structure of Ronan Point and other Taylor Woodrow – Anglian buildings, Building Research Establishment, Department of Environment, 1985
- [2] Handbook for the Structural Assessment of Existing Large Panel (LPS) Dwelling Blocks for Accidental Loads, Stuart Matthews and Barry Reeves, Building Research Establishment, Communities and Local Government, 2012
- [3] Structure: Approved Document A, The Building Regulations 2010, Department for Communities and Local Government
- [4] Circular 62/68, Flats constructed with pre-cast concrete panels. Appraisal and strengthening of existing high blocks: Design of new blocks, Ministry of Housing and Local Government, 15 November 1968
- [5] Circular 71/68, Flats constructed with pre-cast concrete panels. Appraisal and strengthening of existing high blocks: Design of new blocks, Ministry of Housing and Local Government, 20 December 1968
- [6] C. Scruton and C. W. Newberry, On the estimation of wind loads for building and structural design, Proceedings of the Institute of Civil Engineers, Volume 25, Issue 2, 1963
- [7] H.C. Shellard, Extreme wind speeds over the United Kingdom for periods ending in 1963, Meteorological Office Climatological Memorandum No 50
- [8] Statutory Instruments 1970 No. 109, Building and Buildings, The Building (Fifth Amendment) Regulations 1970
- [9] Martech Technical Services Ltd, 21 Church Street, Sawtry, Huntingdon, Cambridgeshire, PE28 5SZ
- [10] The Building Regulations 2010, Building and Buildings, England and Wales
- [11] Eurocode 0: Basis of structural design, BS EN 1990
- [12] Eurocode 1: Actions on structure, BS EN 1991
- [13] Eurocode 1: Part 4, Actions on structure: Wind Action, BS EN 1991-1-4:2005
- [14] Eurocode 2: Design of concrete structures – Part 1-1: General rules and rules for buildings, BS EN 1992-1-2004+A1:2014
- [15] Larsen and Nielsen system, Architect and Building News, Nov 14 1962
- [16] Warner Surveys, G.3 Bedford House, 69-79 Fulham High Street, London, SW6 3JW

- [17] Ledbury Estate, Structural Robustness Assessment for Large Panel System Tower Blocks with Piped Gas, Ove Arup and Partners Ltd, August 2017

Appendix A Phase 2 Disproportionate Collapse Assessment

This appendix is an extract from Section 4 of “Ledbury Estate, Structural Robustness Assessment for Large Panel System Tower Blocks with Piped Gas” August 2017 [17].

Assessment

Assessment discussion

In the event of an explosion in the kitchen in one of the tower blocks at Ledbury Estate the flank wall and first internal wall could experience a pressure of 34kPa (piped gas). Two failure mechanisms have been considered.

- Failure of the wall panel
- Failure of the joint at the head or base of the wall which ties it back to the floor or to the wall panel above or below

Our investigations indicate that the flank have minimal reinforcement*, while the cross-walls are unreinforced concrete. As such the walls do not have sufficient capacity to resist 34kPa (accidental load requirement for a block with piped gas) or 17kPa (accidental load requirement for a block with bottled gas) and as such the walls surrounding the explosion will fail. This has consequences to the floor immediately above which relies on the walls for support.

There is likely to be significant damage to the floor slabs in the room where the explosion occurs. The walls and floors that that would be affected by an explosion in the kitchen can be seen in Figure 13.

** The original report issued on 30 August 2017 stated that the flank walls were unreinforced. Further intrusive investigations during Phase 3 located a 6mm mesh at ~150mm centres, located at a depth of 125mm from the inside wall face. This new information does not change the conclusions for the Phase 2 assessment.*

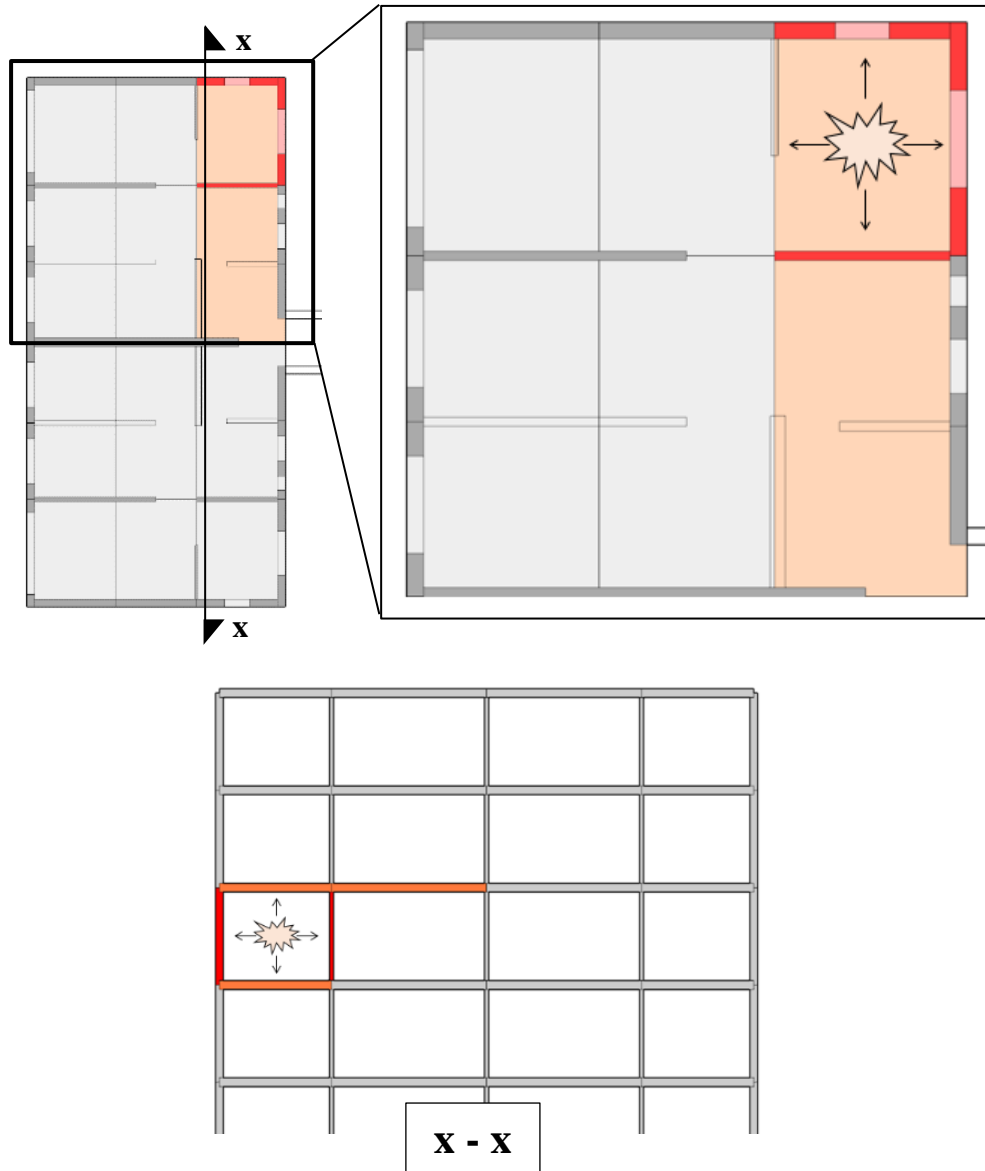

Figure 13 Plan view (above) and section view (below). The walls affected by an explosion occurring in the kitchen are highlighted in red. The affected floor slabs are highlighted in orange.

With the loss of the flank wall and the first internal wall, the floor on the level above the explosion will no longer have support from below and will try to vertically suspend from the wall above. Our investigations indicate that the floor slabs are connected to the wall below but are not directly connected to each other or to the wall above. Our investigations indicate that there are only two vertical bars per wall panel which continue from the wall panel to the wall panel above. The vertical bars are not capable of supporting the weight of the slab in tension and as such in the event of the wall failing below, then the floor previously supported by that wall would also collapse, see Figure 14. The area of the floor that would fail is greater than 15% of the total floor area (at that level) which is not compliant with the regulations for disproportionate collapse, see Figure 15.

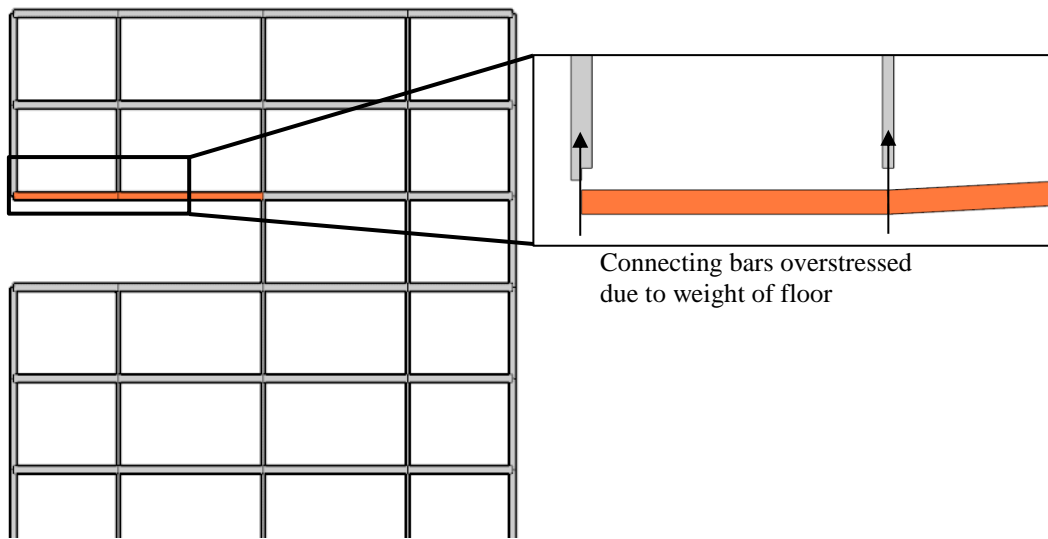

Figure 14 With the loss of the flank wall and the first internal wall, the floor on the level above the explosion will no longer have support from below and will try to vertically suspend from the wall above. The connecting steel reinforcement bar would become overstressed due to the weight of the floor, leading to the tensile failure of this connection.

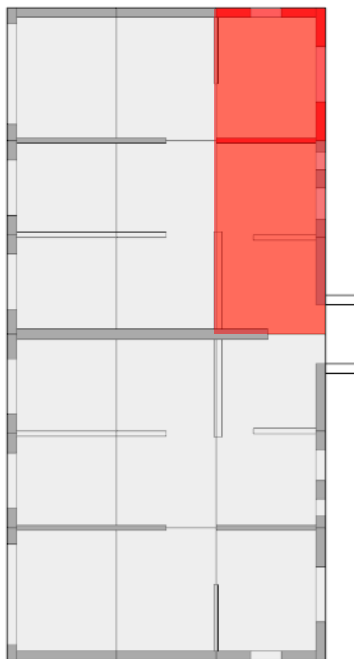

Figure 15 The area of the floor that would fail (highlighted in red) is greater than 15% of the total floor area (at that level)

There is a possibility that such a failure would propagate to the failure of additional elements, causing progressive collapse such as was the case at Ronan Point, but without a fuller understanding of the structural details it is not possible at this time to conclusively conclude the full extent of damage.

Therefore, as described above, in the event of a gas explosion the walls are not able to resist the blast load of 34kPa (for piped gas) or 17kPa (for bottled gas) and therefore would fail the LPS Criterion 2 (as defined by BRE [2]). With the flank wall and/or the first internal wall removed, the floor slabs of the level above are not adequately tied to the walls above or to each other and thus there is no reliable alternative path of support and therefore cannot be shown to meet LPS Criterion 3 (as defined by BRE [2]).

Some of the tying details discovered during our investigations, specifically the vertical ties between floor panels and walls and horizontal internal ties do not comply with Approved Document A – Structure and thus fail LPS Criterion 1 (as defined by BRE [2]).

In conclusion, based in the information available from the (Stage 1) investigations the building does not appear to be sufficiently robust to resist a gas explosion without incurring disproportionate collapse.

These investigations showed that the flank walls and vertical (tension) ties between the floors and walls are not robust enough for buildings with piped gas (using the BRE assessment criterion).

Appendix B Strengthening Details

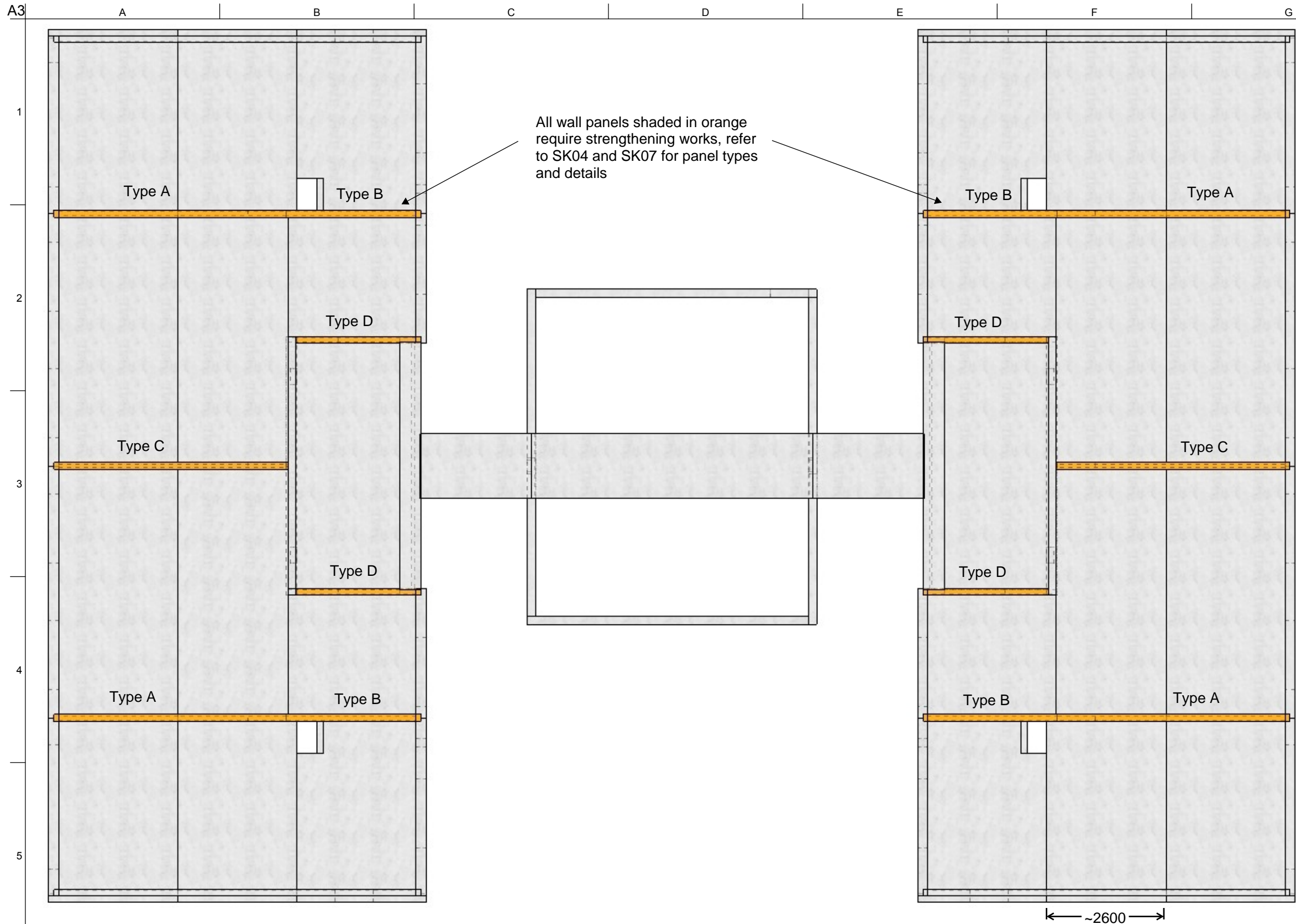

All wall panels shaded in orange require strengthening works, refer to SK04 and SK07 for panel types and details

Cross-wall panel strengthening layout
Sarnsfield House - level 8 to roof - 6 storeys
Bromyard House - level 8 to roof - 6 storeys

Note:
 The following floors have the same wall layout but do not require cross-wall strengthening works:
 Sarnsfield House - 3 storeys (level 5 to level 7)
 Bromyard House - 3 storeys (level 5 to level 7)

- Notes**
1. This drawing is indicative only and not for construction.
 2. All dimensions are indicative and should be verified on site
 3. Access will be required to the concrete face on both sides of each wall highlighted in orange to carry out the strengthening works. This will require local removal and reinstatement of all finishes, including:
 - floor screeds
 - bathroom and kitchen fittings
 - plaster and other wall finishes
 - radiators and radiator pipework, electrical and any other existing services
 - roof finishes
 4. All steel to be S355 structural steel, primed and fire protected to achieve 120 minutes fire resistance

P1	20/11/17	AB	IF	AL
Issue	Date	By	Chkd	Appd



Client
 Southwark Council

Job Title
 Ledbury Estate

Drawing Title
 Cross-wall Strengthening

Scale at A3	NTS		
Discipline	Structure		
Job No	245112-05	Drawing Status	Preliminary
Drawing No	SK 01	Issue	P1

A3

A B C D E F G

1

2

3

4

5

6

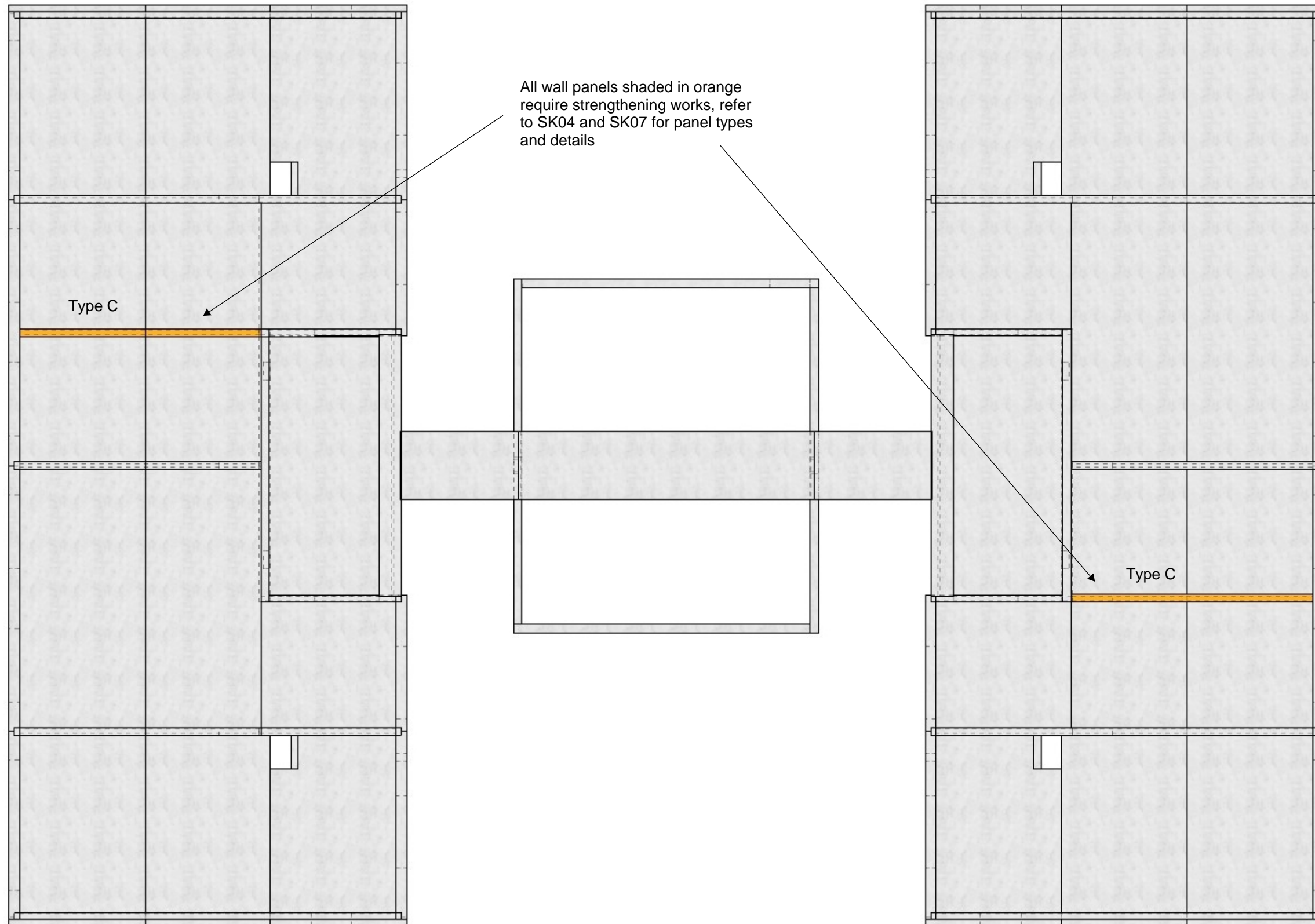

All wall panels shaded in orange require strengthening works, refer to SK04 and SK07 for panel types and details

Type C

Type C

Cross-wall panel strengthening layout
Sarnsfield House - ground to level 4 - 5 storeys
Bromyard House - ground to level 4 - 5 storeys

~2600

Notes

1. This drawing is indicative only and not for construction.
2. All dimensions are indicative and should be verified on site
3. Access will be required to the concrete face on both sides of each wall highlighted in orange to carry out the strengthening works. This will require local removal and reinstatement of all finishes, including:
 - floor screeds
 - bathroom and kitchen fittings
 - plaster and other wall finishes
 - radiators and radiator pipework, electrical and any other existing services
 - roof finishes
4. All steel to be S355 structural steel, primed and fire protected to achieve 120 minutes fire resistance

P1	20/11/17	AB	IF	AL
Issue	Date	By	Chkd	Appd

ARUP

Client
Southwark Council

Job Title
Ledbury Estate

Drawing Title
Cross-wall Strengthening

Scale at A3
NTS
Discipline
Structure

Job No
245112-05
Drawing Status
Preliminary

Drawing No
SK 02
Issue
P1

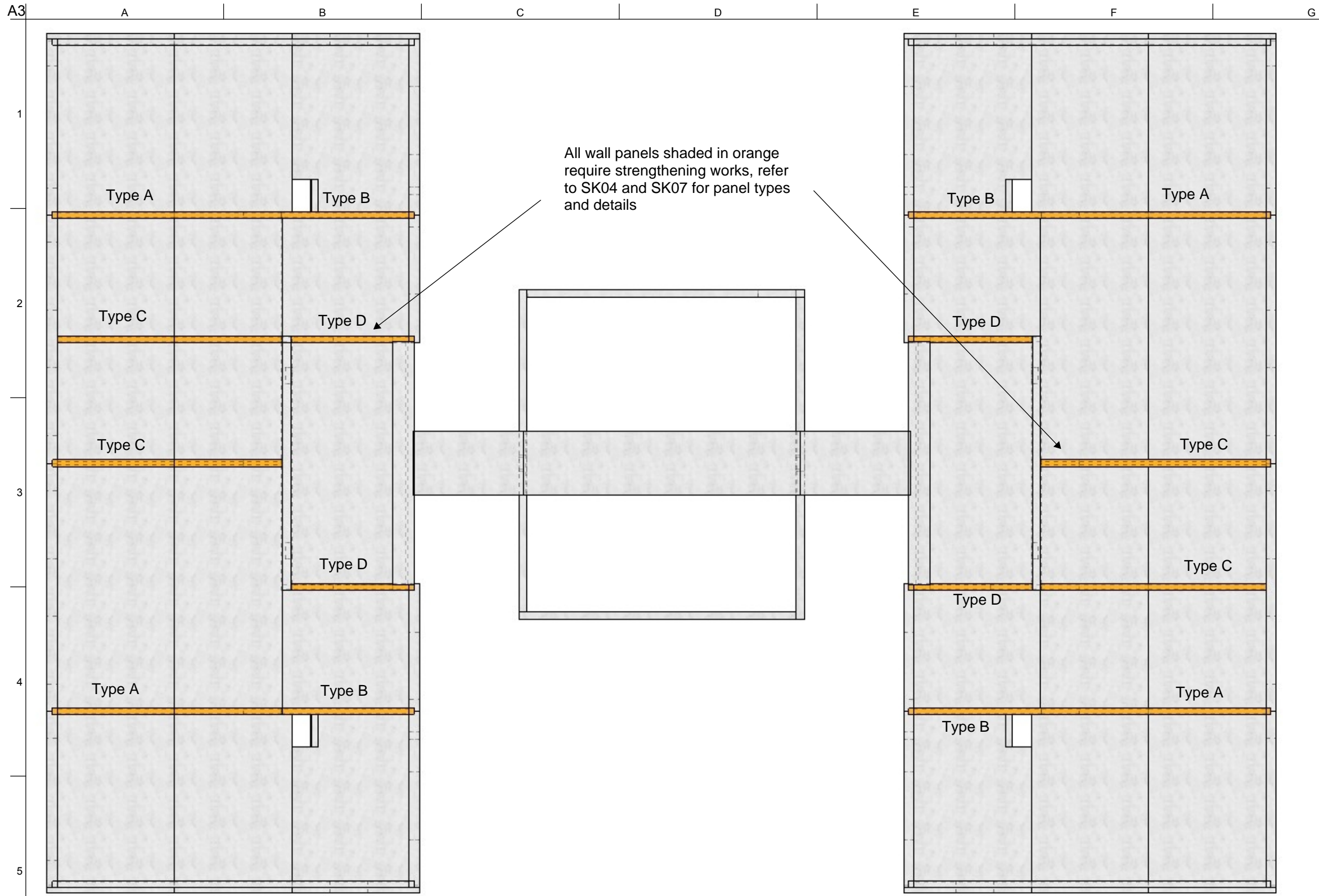

All wall panels shaded in orange require strengthening works, refer to SK04 and SK07 for panel types and details

Cross wall panel strengthening layout
 Skenfrith House - level 8 to roof - 6 storeys
 Peterchurch House - level 8 to roof - 6 storeys

Note:
 The following floors have the same wall layout but do not require cross wall strengthening works:
 Skenfrith House - Ground to level 7
 Peterchurch House - Ground to level 7

- Notes
1. This drawing is indicative only and not for construction.
 2. All dimensions are indicative and should be verified on site
 3. Access will be required to the concrete face on both sides of each wall highlighted in orange to carry out the strengthening works. This will require local removal and reinstatement of all finishes, including:
 - floor screeds
 - bathroom and kitchen fittings
 - plaster and other wall finishes
 - radiators and radiator pipework, electrical and any other existing services
 - roof finishes
 4. All steel to be S355 structural steel, primed and fire protected to achieve 120 minutes fire resistance

P1	20/11/17	AB	IF	AL
Issue	Date	By	Chkd	Appd



Client
 Southwark Council

Job Title
 Ledbury Estate

Drawing Title
 Cross-wall Strengthening

Scale at A3	NTS		
Discipline	Structure		
Job No	245112-05	Drawing Status	Preliminary
Drawing No	SK 03	Issue	P1

1

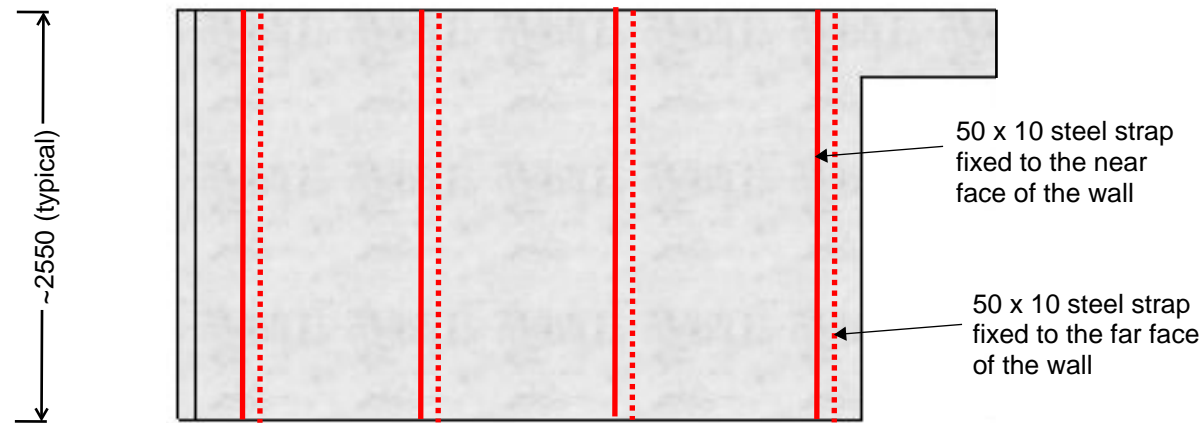

Cross-wall panel Type A

Outsard wall
in kitchen riser
cupboard

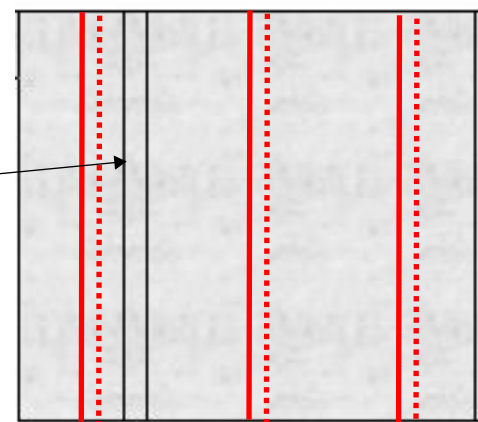

Cross-wall panel Type B

2

3



Cross-wall panel Type C

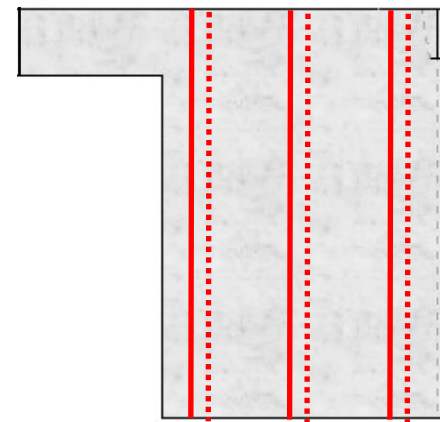

Cross-wall panel Type D

Note: refer to SK01 to SK03 for panel locations and to SK07 for details

Notes

1. This drawing is indicative only and not for construction.
2. All dimensions are indicative and should be verified on site
3. Access will be required to the concrete face on both sides of each wall highlighted in orange to carry out the strengthening works. This will require local removal and reinstatement of all finishes, including:
 - floor screeds
 - bathroom and kitchen fittings
 - plaster and other wall finishes
 - radiators and radiator pipework, electrical and any other existing services
 - roof finishes
4. All steel to be S355 structural steel, primed and fire protected to achieve 120 minutes fire resistance

P1	20/11/17	AB	IF	AL
Issue	Date	By	Chkd	Appd

ARUP

Client
Southwark Council

Job Title
Ledbury Estate

Drawing Title
Cross-wall Strengthening

Scale at A3
NTS

Discipline
Structure

Job No
245112-05

Drawing Status
Preliminary

Drawing No
SK 04

Issue
P1

A3

A B C D E F G

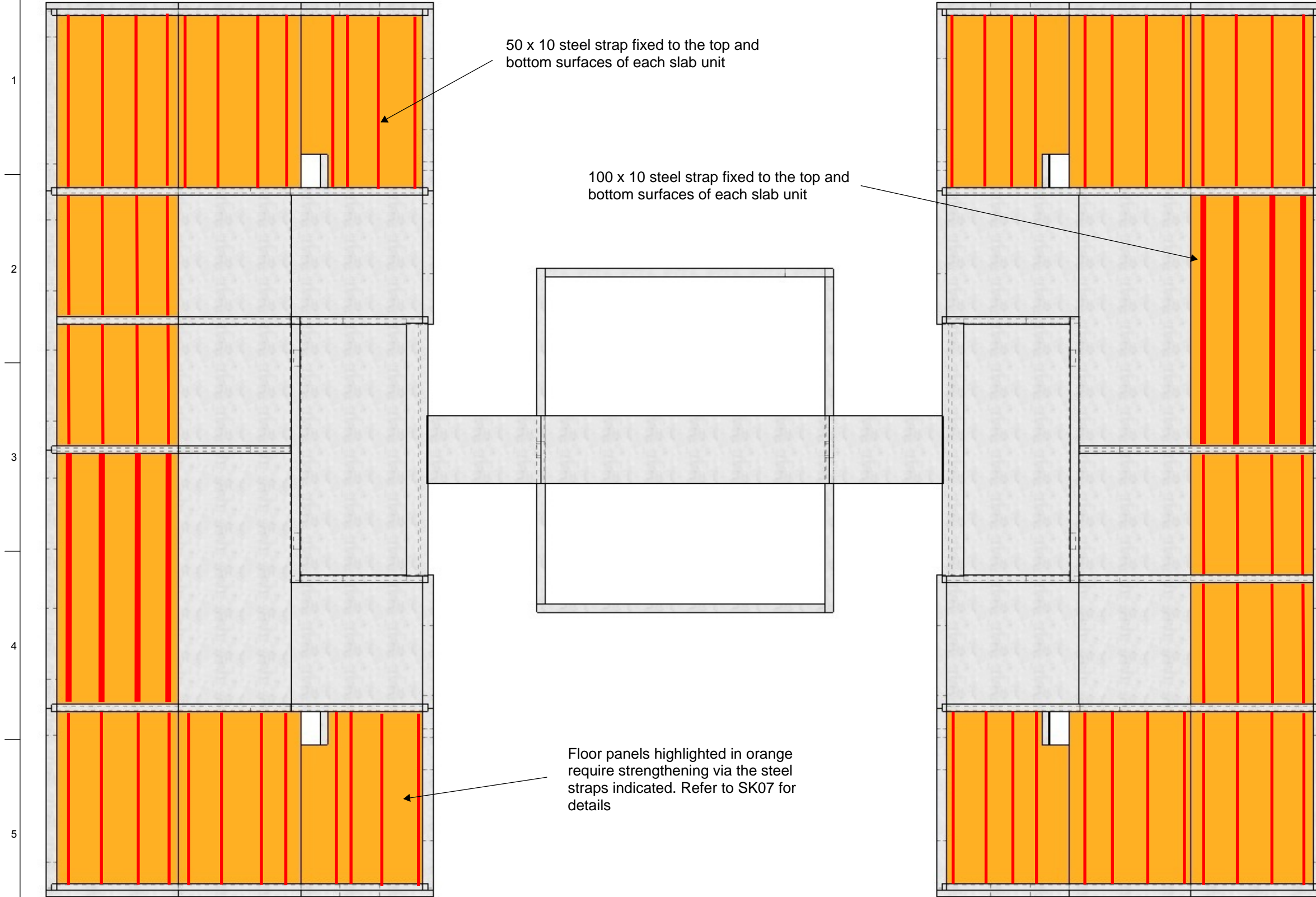

50 x 10 steel strap fixed to the top and bottom surfaces of each slab unit

100 x 10 steel strap fixed to the top and bottom surfaces of each slab unit

Floor panels highlighted in orange require strengthening via the steel straps indicated. Refer to SK07 for details

3 bed/1 bed layout - floor panel strengthening layout

This layout applies in the following locations:

- Sarnsfield House - 4 floors thus (for remaining floors refer to SK06)
- Bromyard House - 4 floors thus (for remaining floors refer to SK06)
- Peterchurch House - 14 floors thus (including roof)
- Skenfrith House - 14 floors thus (including roof)

Notes

1. This drawing is indicative only and not for construction.
2. All dimensions are indicative and should be verified on site
3. Access will be required to both top and bottom surfaces of the structural slabs to carry out the strengthening works. This will require local removal and reinstatement of all finishes, including:
 - floor screeds
 - bathroom and kitchen fittings
 - non-loadbearing walls (at mid-span of the floor panels with 100 x 10 straps)
 - roof finishes
4. All steel to be S355 structural steel, primed and fire protected to achieve 120 minutes fire resistance

P1	20/11/17	AB	IF	AL
Issue	Date	By	Chkd	Appd

ARUP

Client
Southwark Council

Job Title
Ledbury Estate

Drawing Title

Slab Strengthening

Scale at A3	NTS		
Discipline	Structure		
Job No	245112-05	Drawing Status	Preliminary
Drawing No	SK 05	Issue	P1

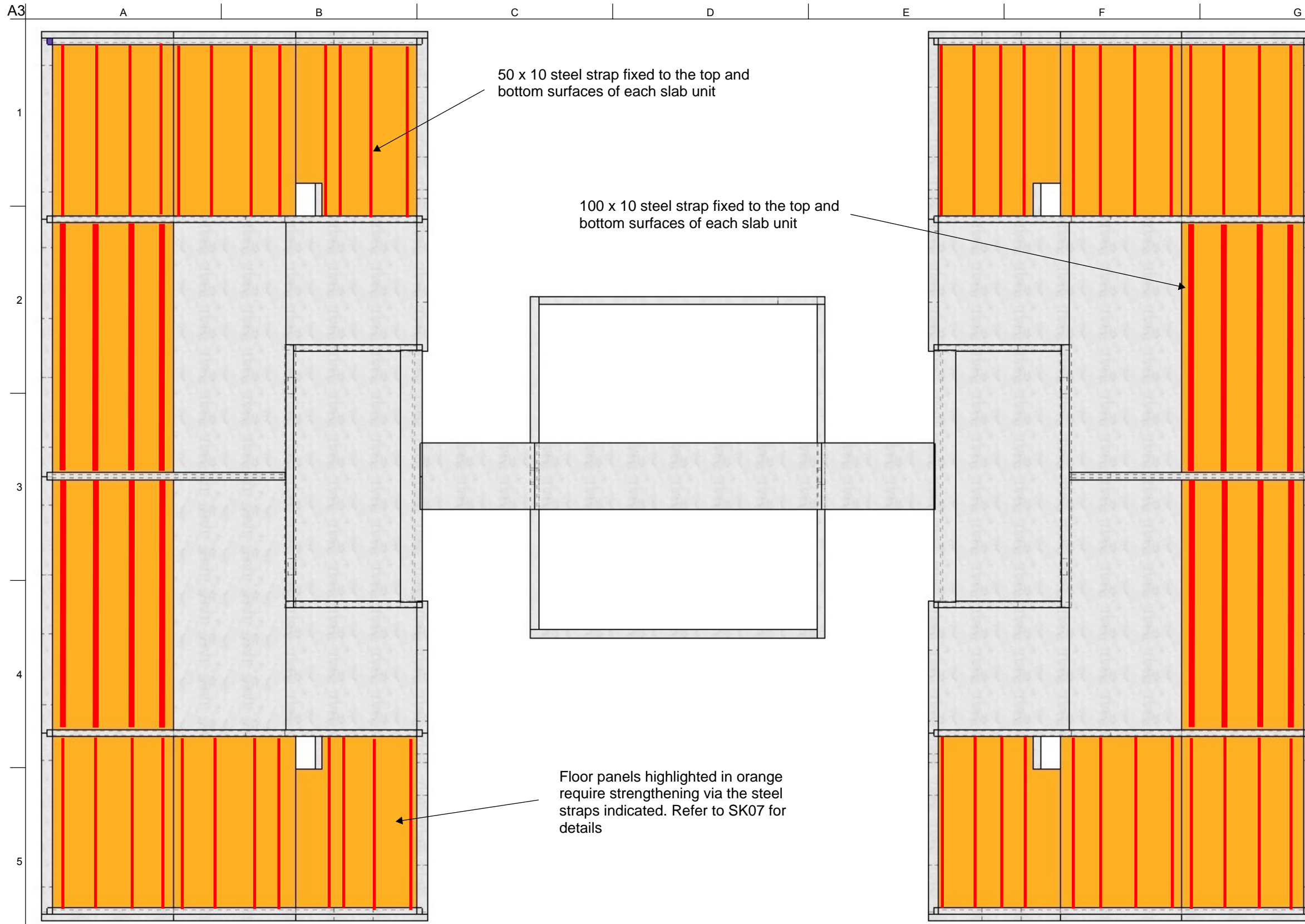

50 x 10 steel strap fixed to the top and bottom surfaces of each slab unit

100 x 10 steel strap fixed to the top and bottom surfaces of each slab unit

Floor panels highlighted in orange require strengthening via the steel straps indicated. Refer to SK07 for details

2 bed/2 bed layout - floor panel strengthening layout

This layout applies in the following locations:
 Sarnsfield House - 10 floors thus (including roof)
 Bromyard House - 10 floors thus (including roof)
 For remaining floors refer to SK05

- Notes
1. This drawing is indicative only and not for construction.
 2. All dimensions are indicative and should be verified on site
 3. Access will be required to both top and bottom surfaces of the structural slabs to carry out the strengthening works. This will require local removal and reinstatement of all finishes, including:
 - floor screeds
 - bathroom and kitchen fittings
 - non-loadbearing walls (at mid-span of the floor panels with 100 x 10 straps)
 - roof finishes
 4. All steel to be S355 structural steel, primed and fire protected to achieve 120 minutes fire resistance

P1	20/11/17	AB	IF	AL
Issue	Date	By	Chkd	Appd

ARUP

Client
Southwark Council

Job Title
Ledbury Estate

Drawing Title
Slab Strengthening

Scale at A3	NTS
Discipline	Structure
Job No	245112-05
Drawing Status	Preliminary
Drawing No	SK 06
Issue	P1

A3

A B C D E F G

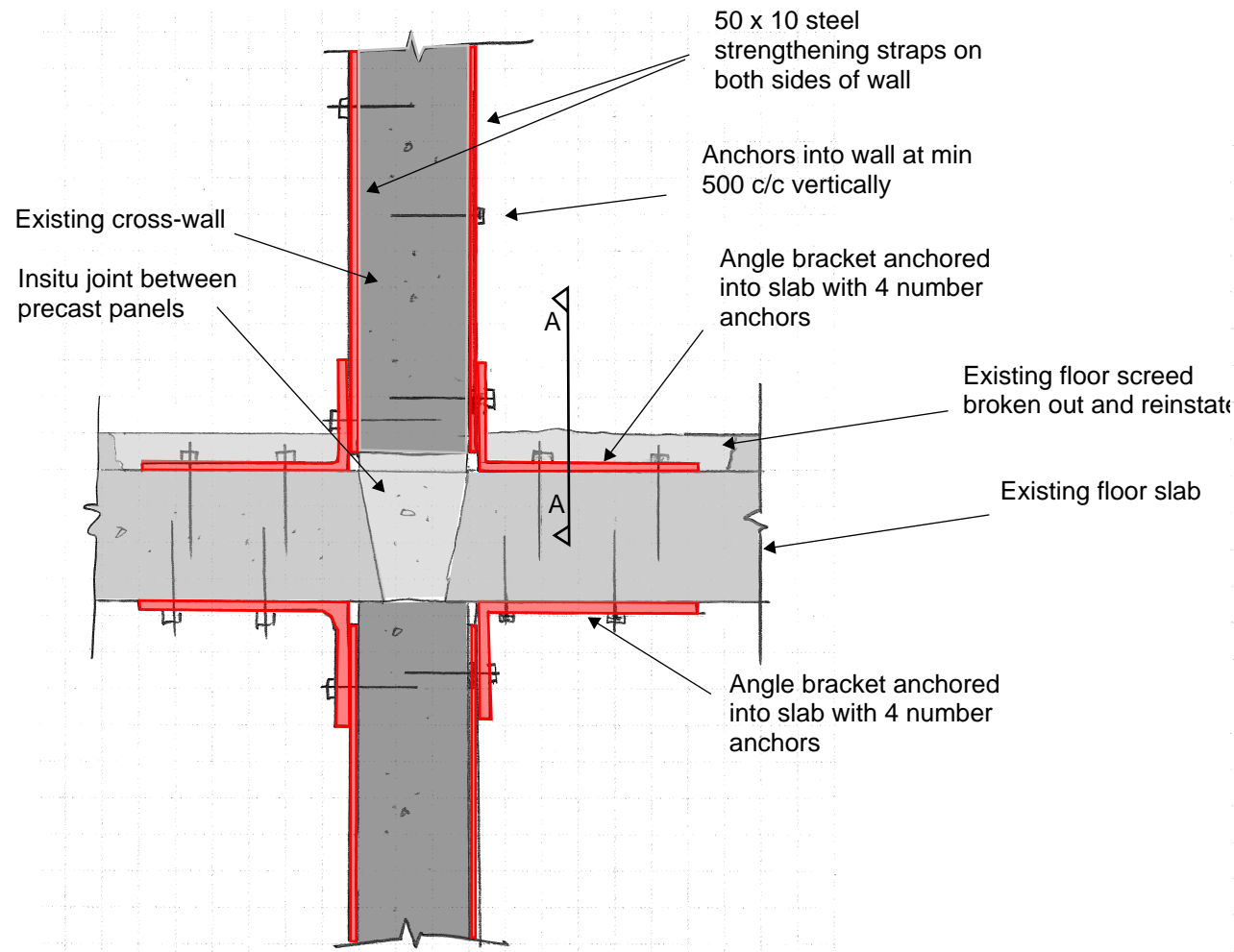

Cross-wall strengthening - detail at connection to floor slab

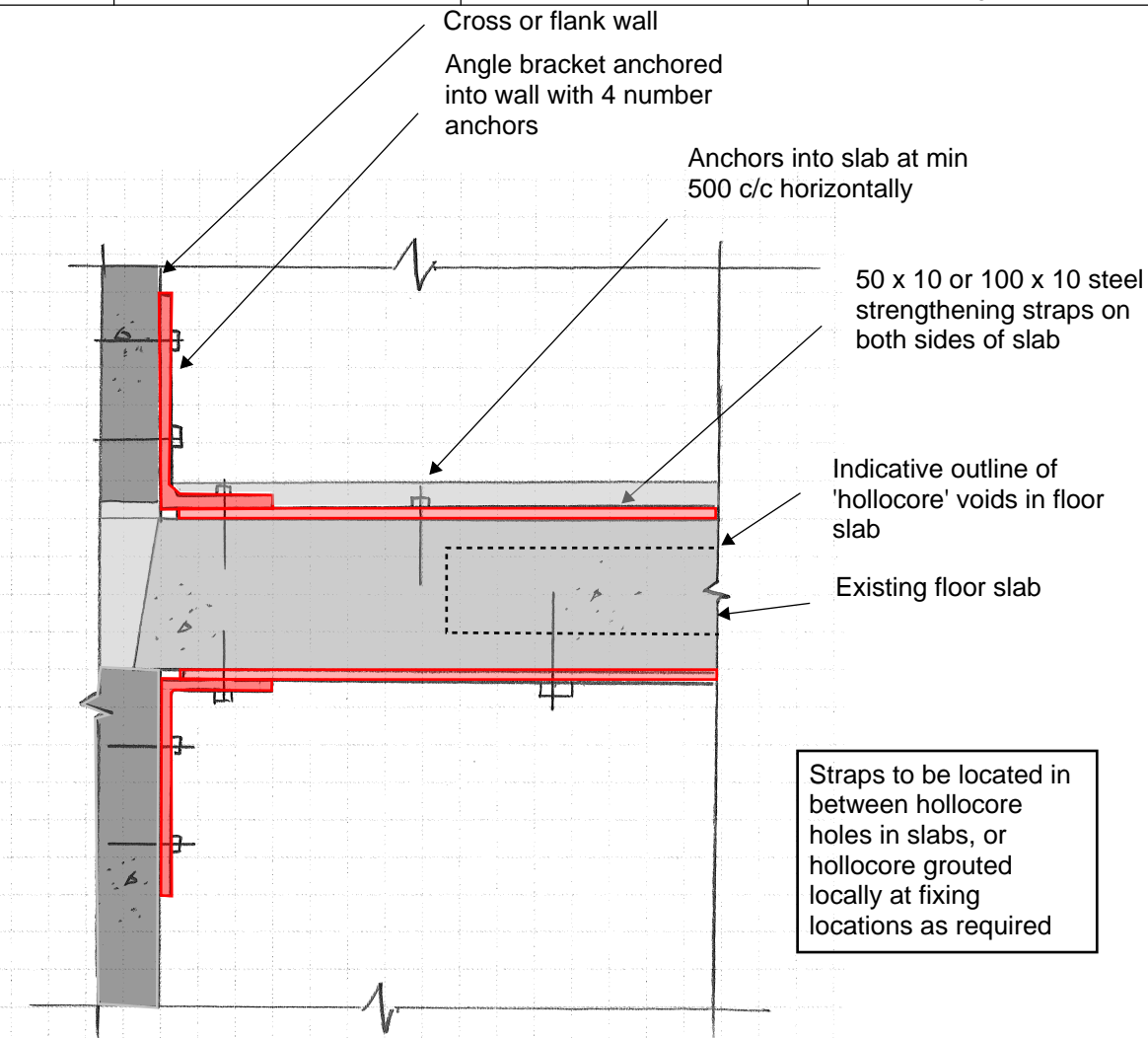

Floor slab strengthening - detail at connection to wall

Refer to SK01 to SK06 for locations of floor and cross wall strengthening works

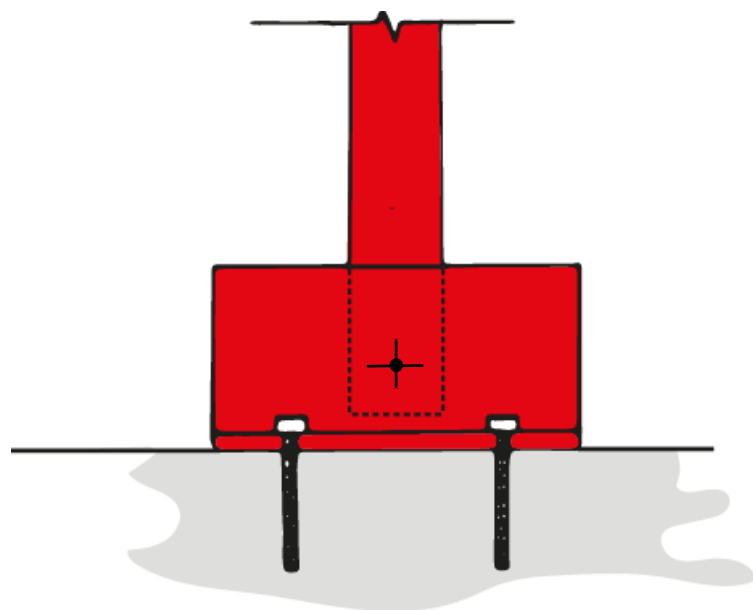

Do not scale

Notes

1. This drawing is indicative only and not for construction.
2. All dimensions are indicative and should be verified on site
3. Access will be required to the concrete face on both sides of each wall highlighted in orange to carry out the strengthening works. This will require local removal and reinstatement of all finishes, including:
 - floor screeds
 - bathroom and kitchen fittings
 - plaster and other wall finishes
 - radiators and radiator pipework, electrical and any other existing services
 - roof finishes
4. All steel to be S355 structural steel, primed and fire protected to achieve 120 minutes fire resistance

P1	20/11/17	AB	IF	AL
Issue	Date	By	Chkd	Appd

ARUP

Client
Southwark Council

Job Title
Ledbury Estate

Drawing Title

Cross-wall and floor slab strengthening

Scale at A3
NTS

Discipline
Structure

Job No 245112-05	Drawing Status Preliminary
---------------------	-------------------------------

Drawing No SK 07	Issue P1
---------------------	-------------

© Arup

A3

A B C D E F G

1
2
3
4
5

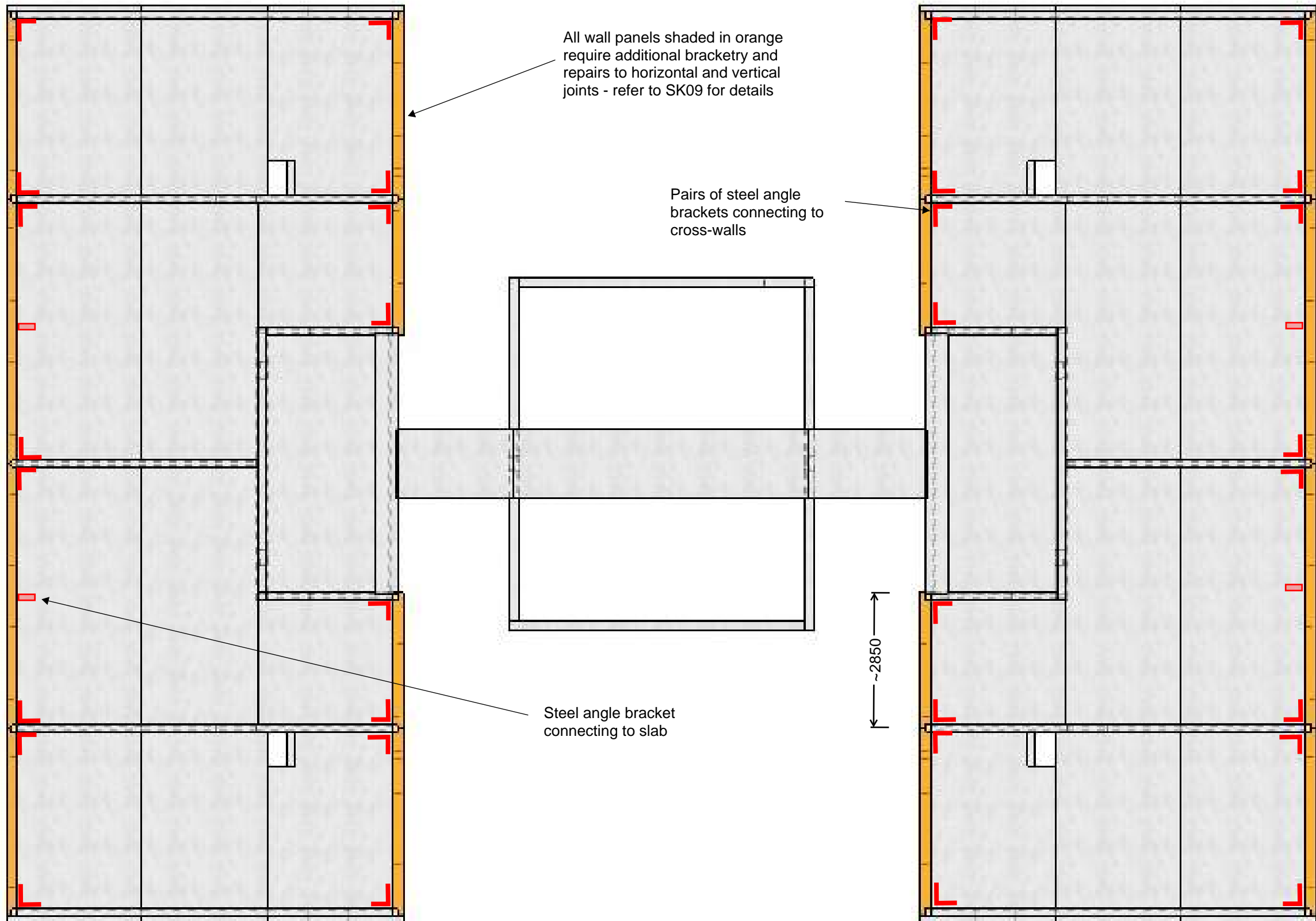

All wall panels shaded in orange require additional bracketry and repairs to horizontal and vertical joints - refer to SK09 for details

Pairs of steel angle brackets connecting to cross-walls

Steel angle bracket connecting to slab

~2850

~5490
~5490
~3880

Notes

1. This drawing is indicative only and not for construction.
2. All dimensions are indicative and should be verified on site
3. Access will require local removal and reinstatement of all finishes, including:
 - floor screeds
 - bathroom and kitchen fittings
 - plaster and other wall finishes
 - radiators and radiator pipework, electrical and any other existing services
4. All steel to be S355 structural steel, primed and fire protected to achieve 120 minutes fire resistance
5. Risk of encountering asbestos in joints to be evaluated by others (not within Arup scope)

P1	20/11/17	AB	IF	AL
Issue	Date	By	Chkd	Appd

ARUP

Client
Southwark Council

Job Title
Ledbury Estate

Drawing Title
External Wall Panel
Internal Repairs
Key Plan

Scale at A3
NTS

Discipline
Structure

Job No 245112-05	Drawing Status Preliminary
---------------------	-------------------------------

Drawing No SK 08	Issue P1
---------------------	-------------

This layout applies in the following locations:
 Sarnsfield House - 14 floors thus
 Bromyard House - 14 floors thus
 Peterchurch House - 14 floor thus
 Skenfrith House - 14 floors thus

Key plan showing walls external wall panels requiring internal repairs and tying
 (2 bed internal floor and wall layout is shown in this diagram, however external wall panel layout is the same in all four blocks)

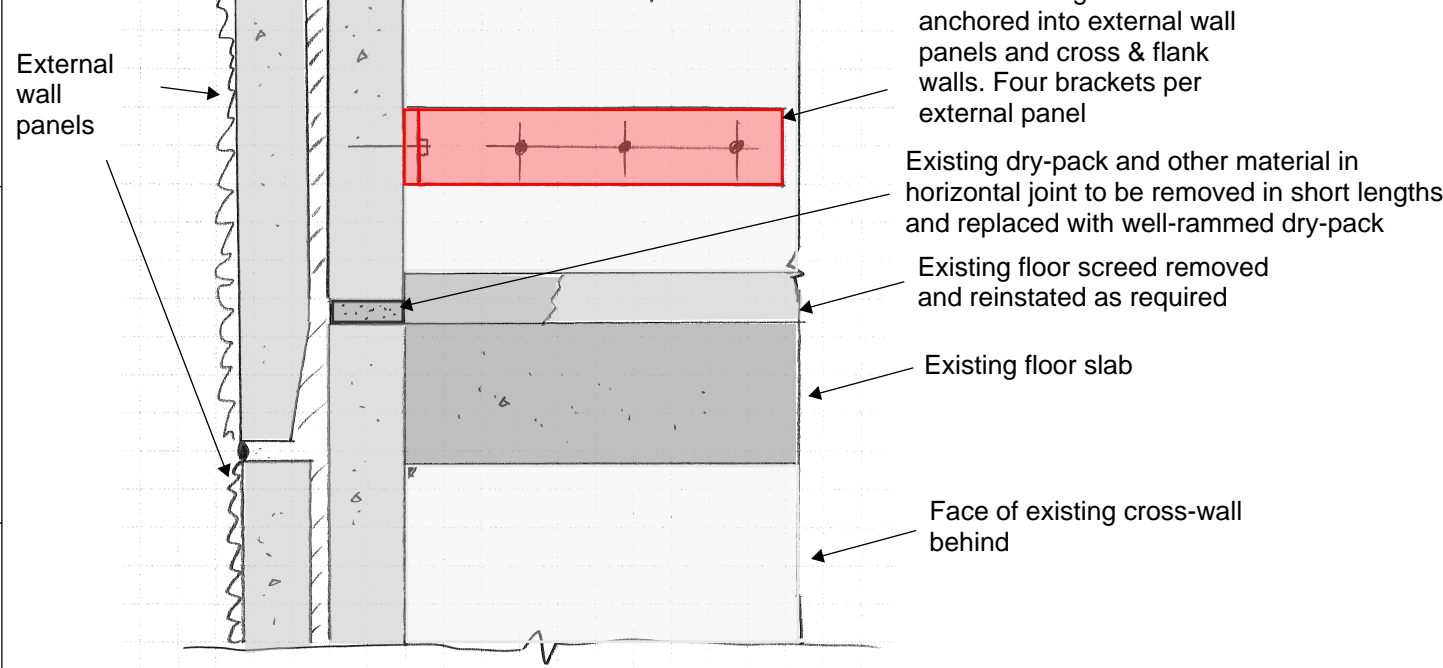

Section A-A

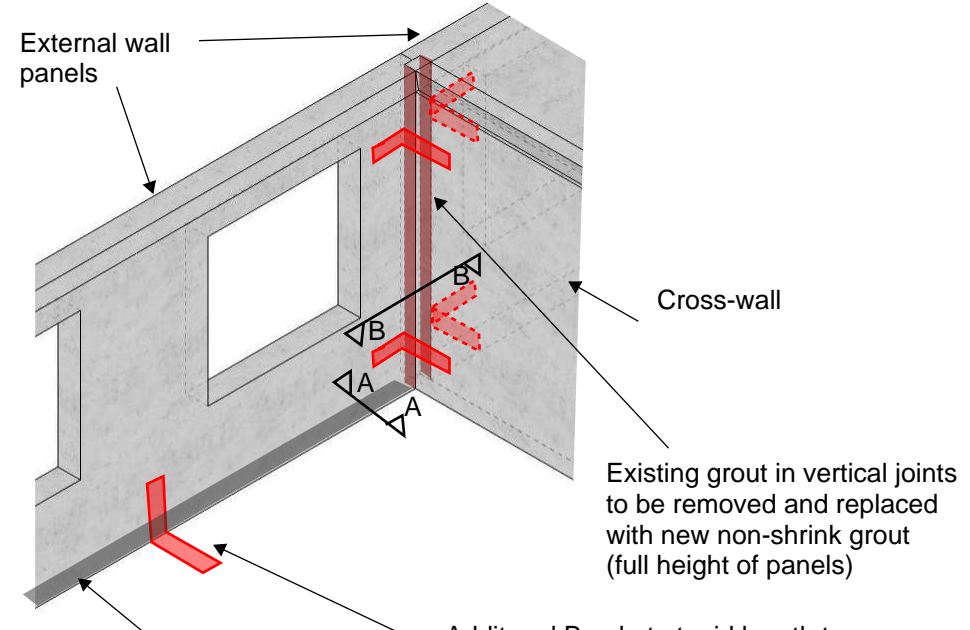

Isometric view of cross-wall / slab edge / external wall panel interface

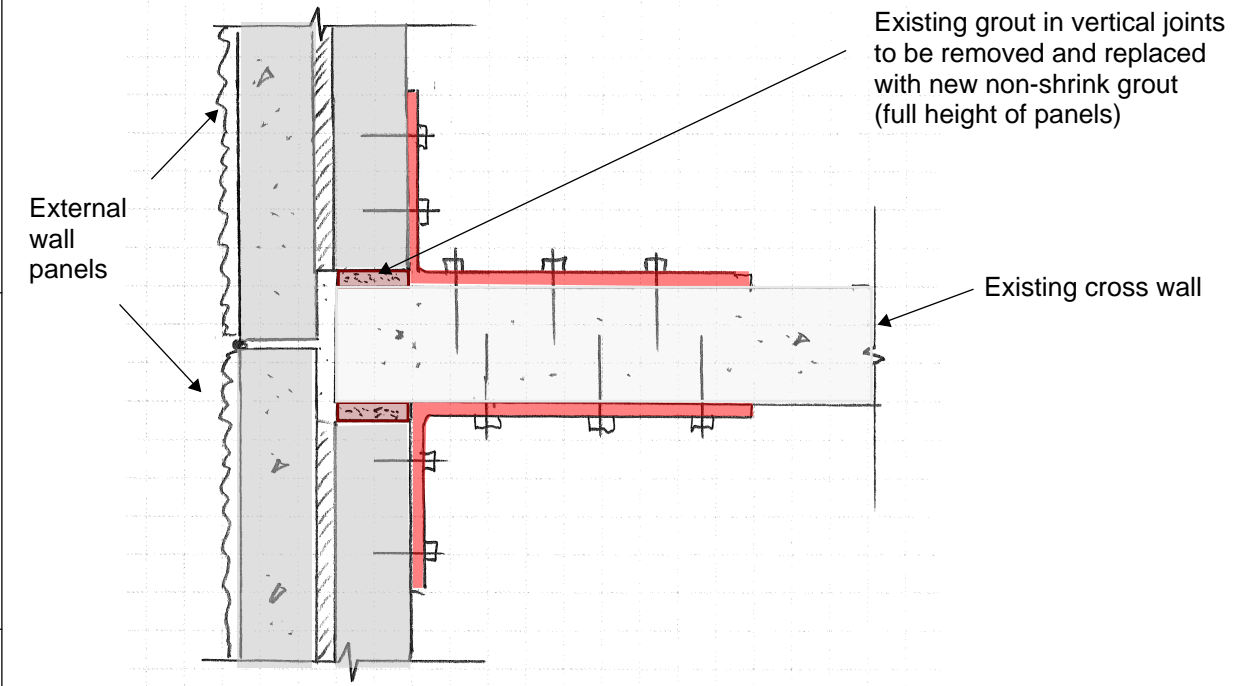

Plan view B-B

Note:

There are sixteen external wall panels per storey per building:

- Twelve of these panels require four steel angle brackets
- Four of these panels require five steel angle brackets
- The total number of steel angle brackets per storey per building is 68 number

The design of these brackets will need to accommodate thermal movements.

The length of horizontal joints to be repacked with dry-pack is approximately 64.5m per storey per building.

The length of vertical joints to be re-grouted is approximately 80.7m per storey per building.

All fourteen storeys of all four buildings require these works.

- Notes**
1. This drawing is indicative only and not for construction.
 2. All dimensions are indicative and should be verified on site
 3. Access will require local removal and reinstatement of all finishes, including:
 - floor screeds
 - bathroom and kitchen fittings
 - plaster and other wall finishes
 - radiators and radiator pipework, electrical and any other existing services
 4. All steel to be S355 structural steel, primed and fire protected to achieve 120 minutes fire resistance
 5. Risk of encountering asbestos in joints to be evaluated by others (not within Arup scope)

P1	20/11/17	AB	IF	AL
Issue	Date	By	Chkd	Appd

ARUP

Client
Southwark Council

Job Title
Ledbury Estate

Drawing Title
External Wall Panels
Internal Repair and Tying
Details

Scale at A3	NTS
Discipline	Structure
Job No	245112-05
Drawing Status	Preliminary
Drawing No	SK 09
Issue	P1