

Pynfolds Estate New Council Homes

WE'RE BUILDING
11,000 NEW
COUNCIL HOMES
ACROSS SOUTHWARK

Project Group Meeting 3 – 29th April 2021

AGENDA FOR THIS EVENING

- Introductions
- Project Group Meeting 03 - purpose
- Last meeting - key slides and feedback
- Existing site
- Proposals/ massing
- Proposals in wider context
- New homes - building plans development
- New Proposed landscape
- Estate landscape
- Wider estate bin storage
- Existing bike storage relocation
- Sketches & materials development
- Elevations
- Sunlight/ daylight
- Next steps
- Contact

NEW HOMES PROJECT GROUP & PROCESS

Stage 0 Start up	Stage 1 Preparation and Brief	Stage 2 Concept Design		Stage 3 Developed Design	Stage 4/5 Tender & Construction	Stage 6 Handover
Residents Drop In	New Homes Project Group Meeting 01	New Homes Project Group Meeting 02	New Homes Project Group Meeting 03	New Homes Project Group Meeting 04	Meet the Contractor	Meet the new New Homes
Introductions	Constraints & opportunities	Design options review - strategic approaches, scale, adjacency, impact	Final concept design review - layouts, landscape, massing, material character	Respond to & review Stage 2 issues, agree actions		
Q&A	Context of existing estate	Agree priorities	Identify further work required	Review proposed developed scheme - plans, materials, functionality		
	Approaches to design	Identify further work required				
	General discussion & feedback	General discussion & feedback	General discussion & feedback	General discussion & feedback		
Project team actions Team appointment	Project team actions Site appraisal Surveys Consultation audit Risk map update Initial brief update Cost check LBS signoff	Project team actions Review & agree preferred option Strategic technical design Pre planning engagement Fire safety engagement Cost update	Project team actions Conclude Stage 2 design Risk update Stage 2 costing LBS signoff	Project team actions LBS signoff	Project team actions	Project team actions

LAST MEETING - KEY SLIDES & FEEDBACK

WIDER ESTATE CONTEXT

- Landscape improvements options could include:
 - new benches, seats & tables
 - communal raised 'allotment'
 - new planting
 - new integrated playground
 - wildlife habitats
- Strategy for car parking offset against keeping green spaces
- Vehicle access - retain full vehicle
- New fire vehicle access
- New approach to bins to dumping issues

Legend:

- BIKE STORE
- PARKING
- BINS
- PLAY AREA
- NEW BLDG
- NEW BUILDING ABOVE
- LANDSCAPE IMPROVEMENT
- VEHICLES & PEDESTRIANS
- PEDESTRIANS ONLY
- EXISTING TREES
- NEW TREES

Callouts:

- Confirmation of commercial units refuse space within project scope
- Relocating storage will be investigated to determine suitability
- Can the existing bike storage be moved under existing arches?
- Additional separate meeting has been arranged to discuss potential options
- Opening up of existing courtyard garden space approach appreciated
- Landscape designs developed with this approach

What do you think? Please let us know - contact information is at the end of this document.

PROPOSED LANDSCAPE

- New homes main entrance from Cathay Street
- Recycling bins relocated within enclosure
- Corner landscape improvements with planting, seating and new fruit trees
- New trees to existing shared amenity
- Sufficient vehicle access for fire safety vehicles
- New dedicated pedestrian access route separate from vehicle access through shared amenity
- New pedestrian routes link with existing courtyard pavements

Legend:

- NEW BLDG
- NEW BUILDING ABOVE
- LANDSCAPE IMPROVEMENT
- VEHICLES & PEDESTRIANS
- PEDESTRIANS ONLY

Callouts:

- Increased to 4 No. 1100 litre bins & enlarged bin store to suit
- Wider estate bin store: 3 No. 660 litre bins as existing not sufficient for 103 residents of the estate
- Suggested tree species have a theme Eg. Magnolia or Cherry
- Tree species theme will be chosen to be complimentary to existing
- Concern that new trees not be planted too close to buildings
- Proximity to existing buildings will be considered to ensure suitable locations
- The roof terrace has been removed, access will be for maintenance only
- Concerns over roof terrace in terms of overlooking & privacy as well as concerns over potential lack of maintenance

What do you think? Please let us know - contact information is at the end of this document.



EXISTING SITE LANDSCAPE

- Off street parking
- Trees
- Bins & telecoms cupboards
- Resident storage units
- Pedestrian estate access

- ▶ Entrance to common stair
- ▶ Main entrance to existing dwelling
- ➔ Vehicle access
- ➔ Pedestrian access

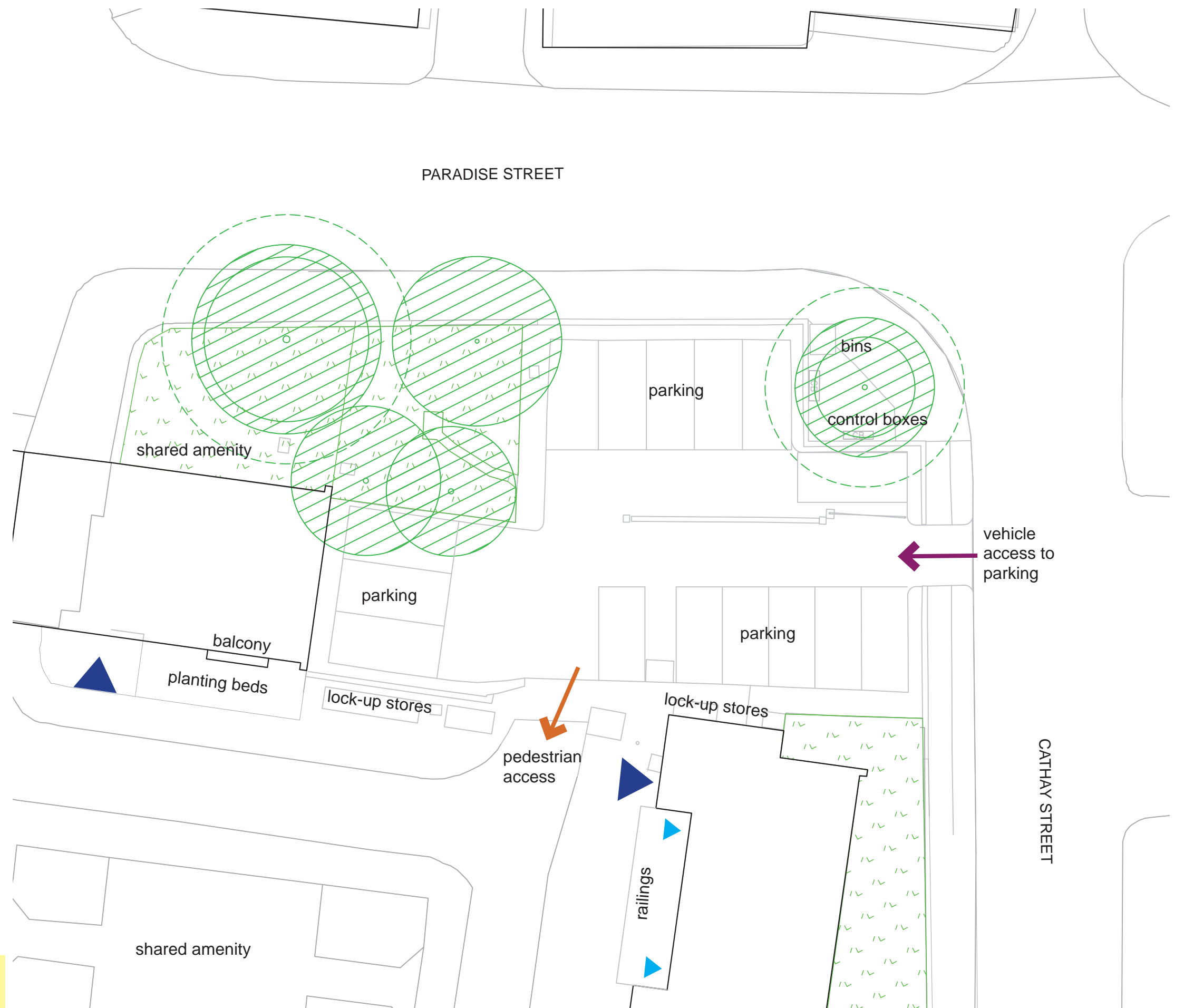

Have we left anything out? Please let us know - contact information is at the end of this document.

PROPOSALS - MASSING

- Defining the Northeast corner of Pynfolds Estate, two connected forms extend from the existing estate blocks to complete the perimeter block of the estate
- A 5 storey block to the East of the site along Cathay Street
- An elevated 2 storey block to West of site
- Angled orientation 'opens' the view of the listed building across the street as it is approached from Cathay Street



North-east



North-west



South-east



South-west

PROPOSAL IN WIDER CONTEXT

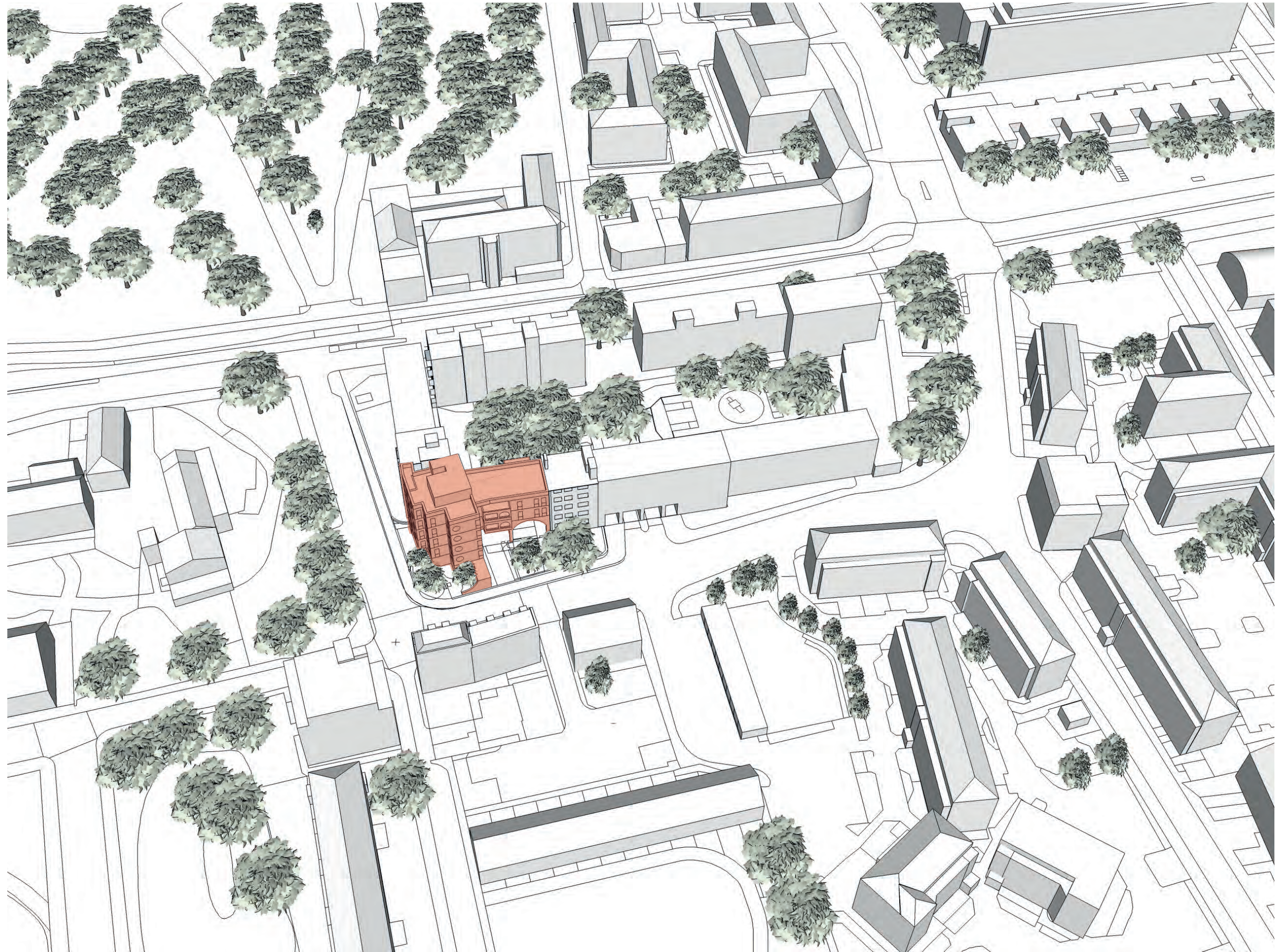

NEW HOMES - BUILDING PLANS

Ground floor plan

1. Entrance Lobby
2. Bicycle store
3. Refuse store
4. Cleaner's Cupboard
5. Communal lift
6. Communal stair
7. Plantroom
8. Wider estate recycling bin store

Changes to plan since Project Group 02:

- Building adjusted to create a lightwell adjacent to existing stairwell windows
- Bin store configuration changed to align with balconies above to visually link new & existing buildings as developed through planning consultation
- Door to bike store moved internally
- Letterboxes moved to external wall
- Windows added to stairwell lobby
- On-going review of wider estate bin store location

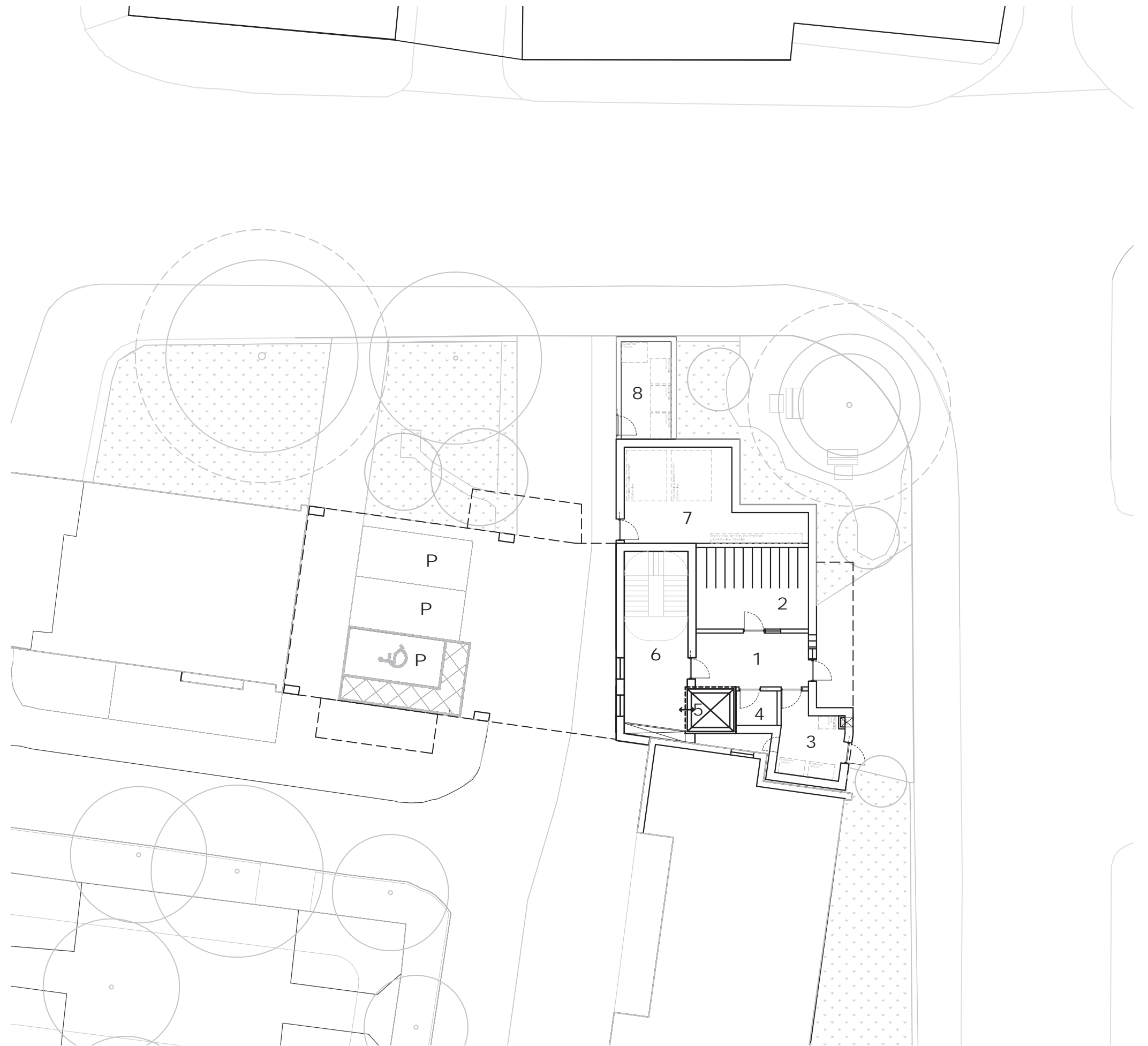

NEW HOMES - BUILDING PLANS

Upper floor plans

1. Kitchen
2. Living Room
3. Balcony
4. Double bedroom
5. Single bedroom
6. Bathroom
7. Flat entrance, hallway & storage
8. Open plan living room (1BR)
9. Communal lobby
10. Communal stair
11. Communal lift
12. External access deck
13. Plant - ASHP enclosures

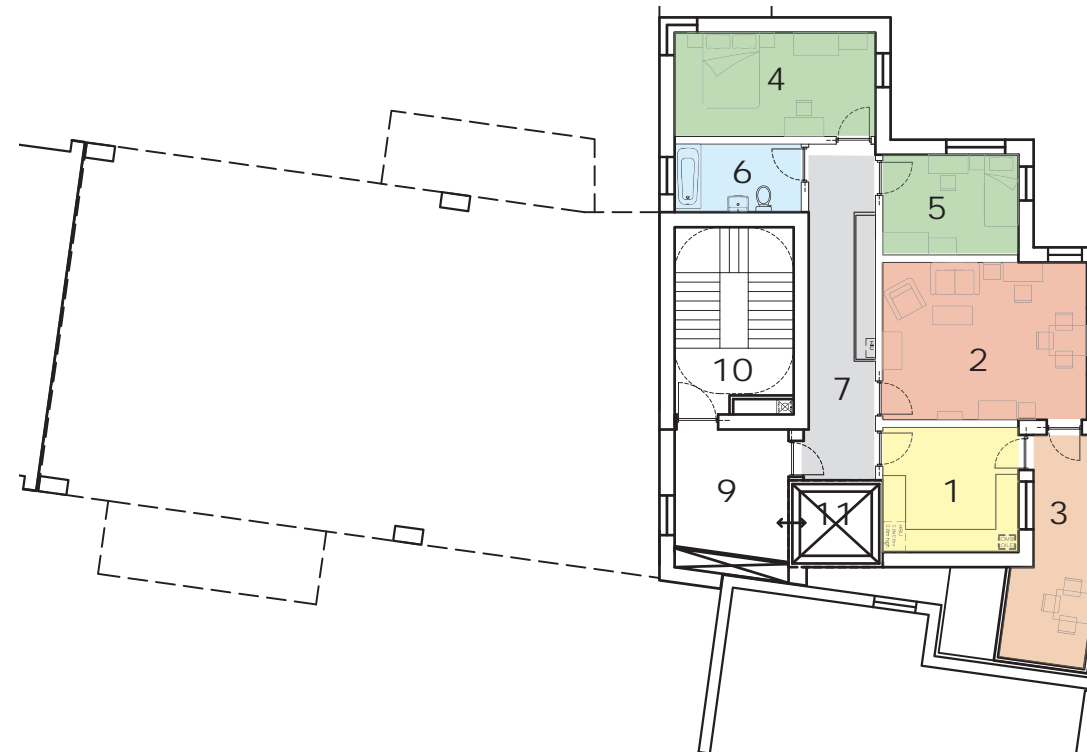

First Floor Plan



Second & Third Floor Plan

Changes to plans since Project Group 02:

- Roof terrace removed - access to roof for maintenance only
- Balconies to courtyard side location moved away from existing estate building
- Balcony configuration along Cathay Street changed to visually link new & existing buildings as developed through planning consultation
- Additional 'step' of building along Cathay Street to adjust to new balcony (as above)
- Elevated building adjusted to align with existing estate building edges
- Window added to first floor lift lobby

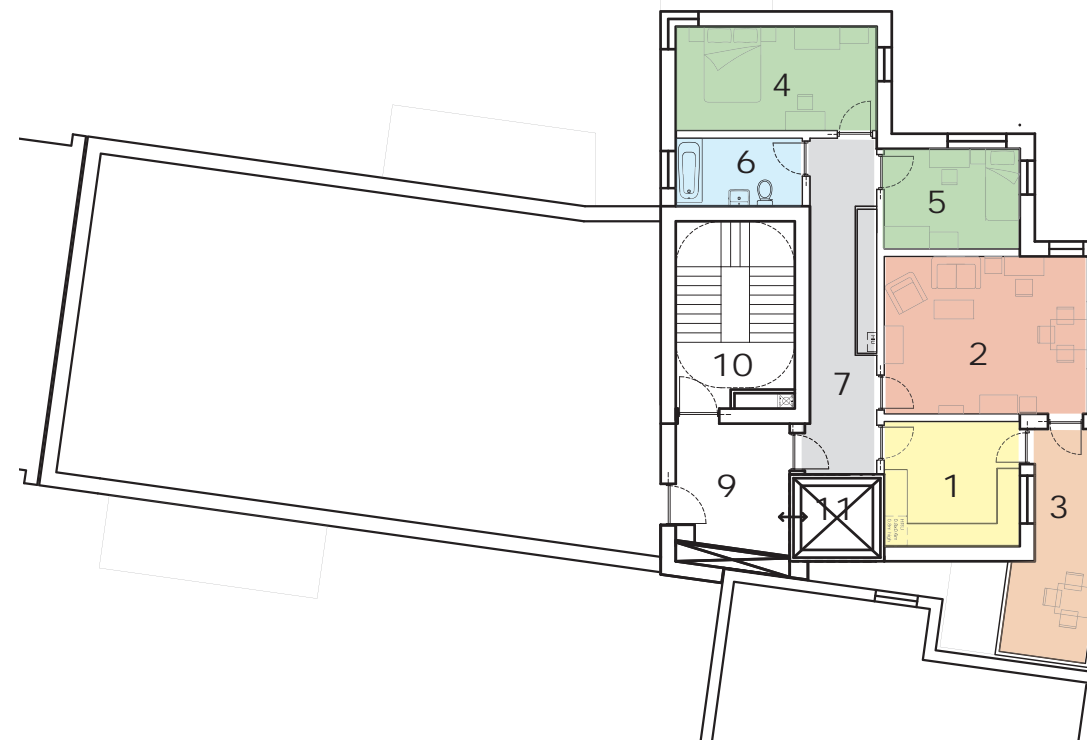

Fourth Floor Plan

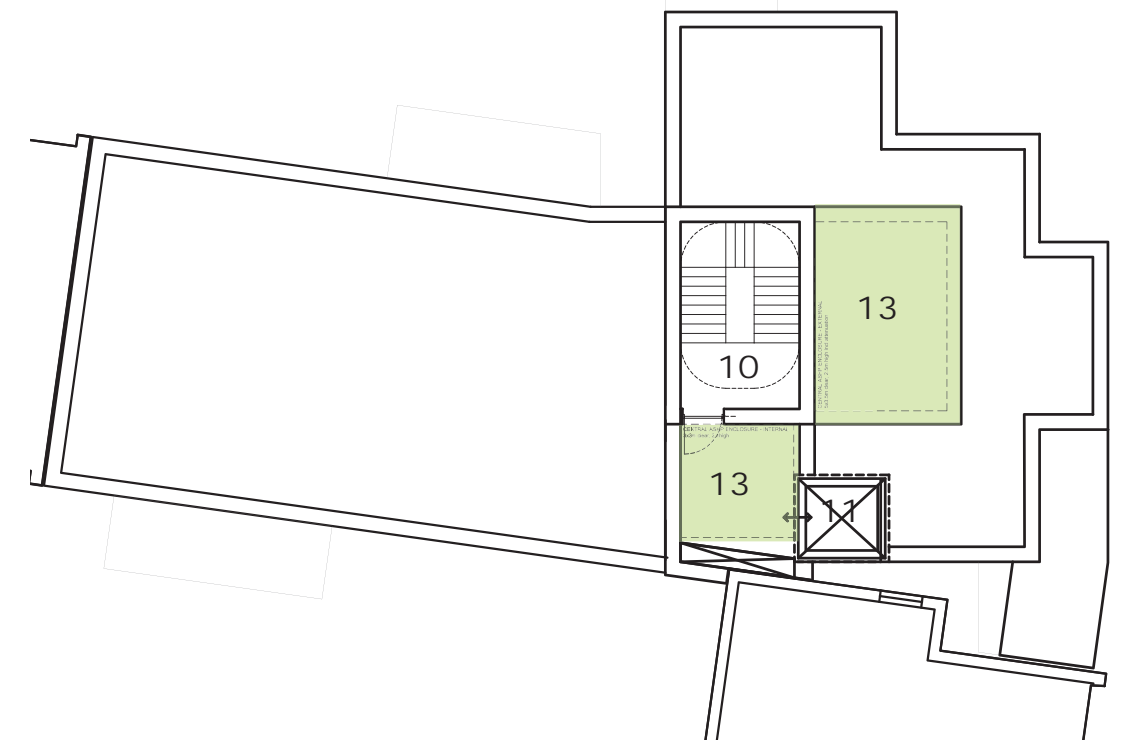

Roof Level Plan

PLAN DEVELOPMENT - PROJECT GROUP 2 PLANS

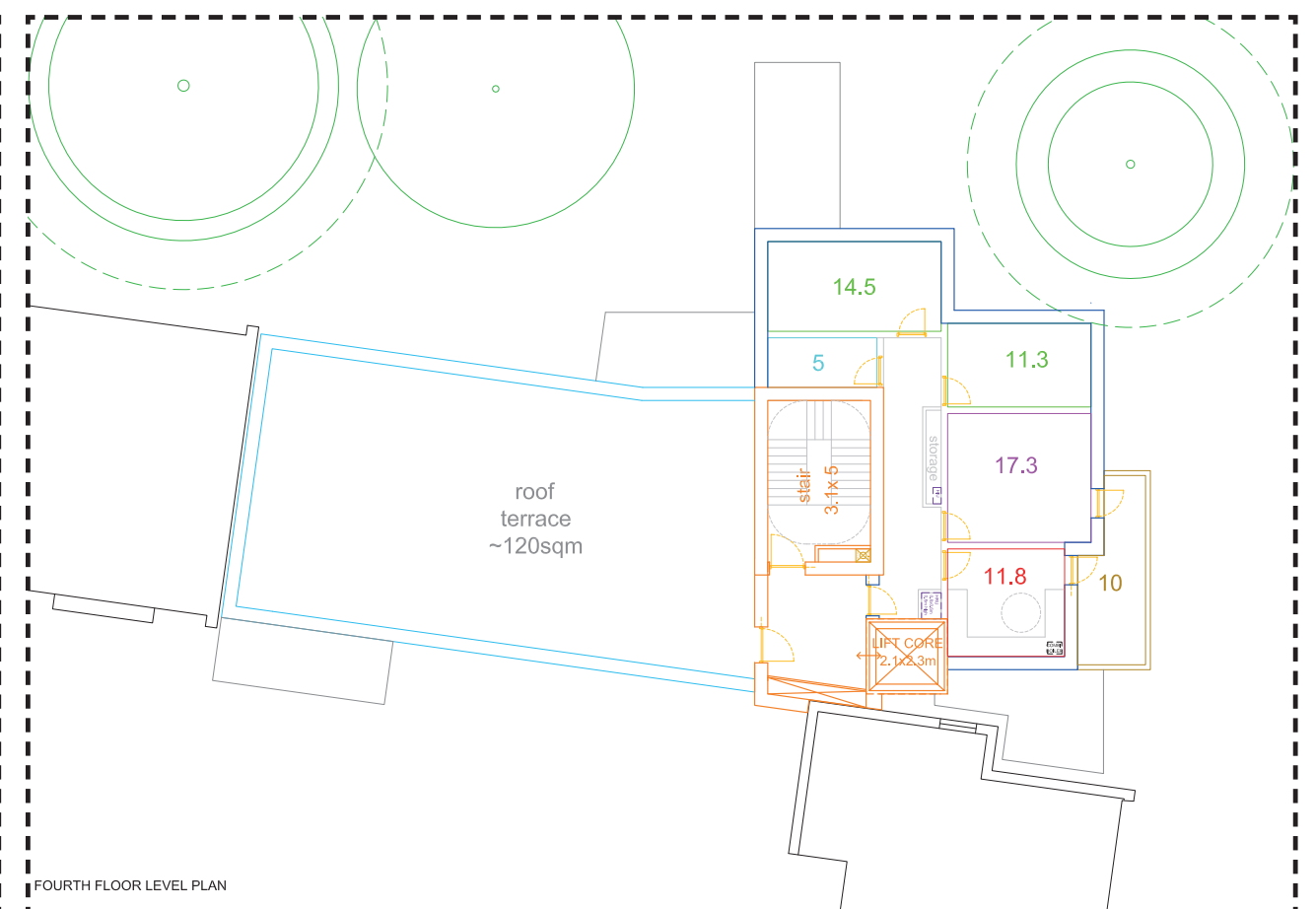
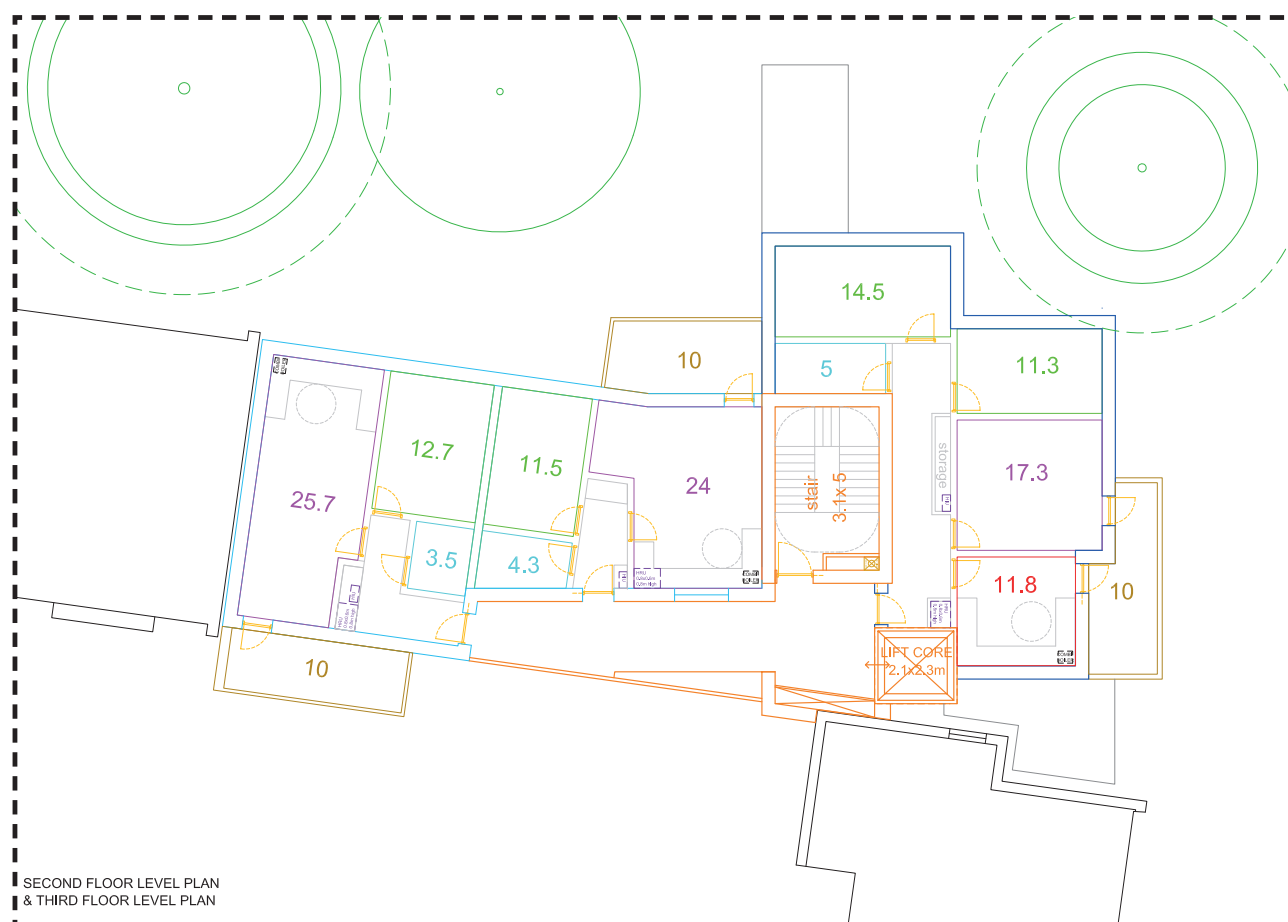
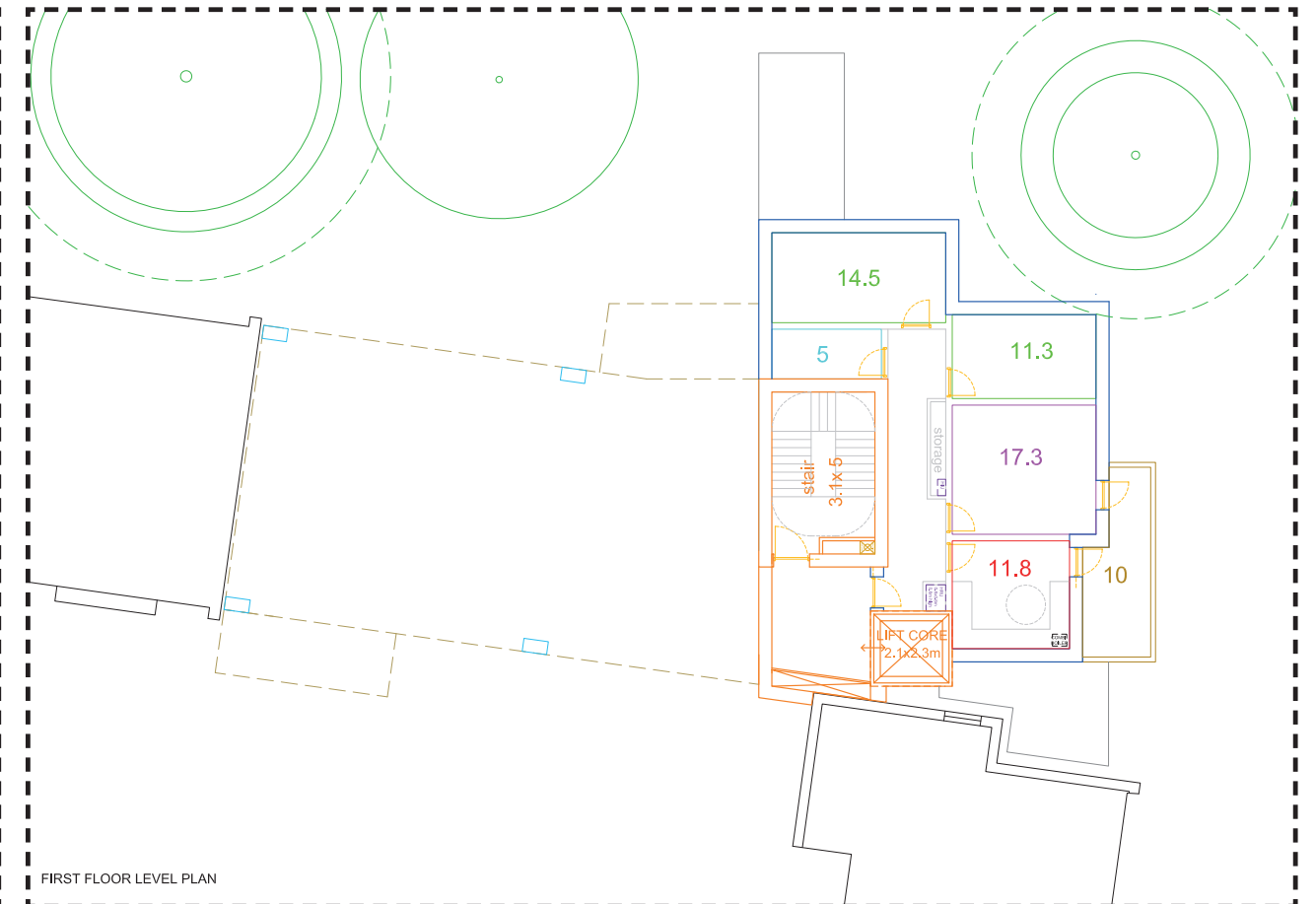
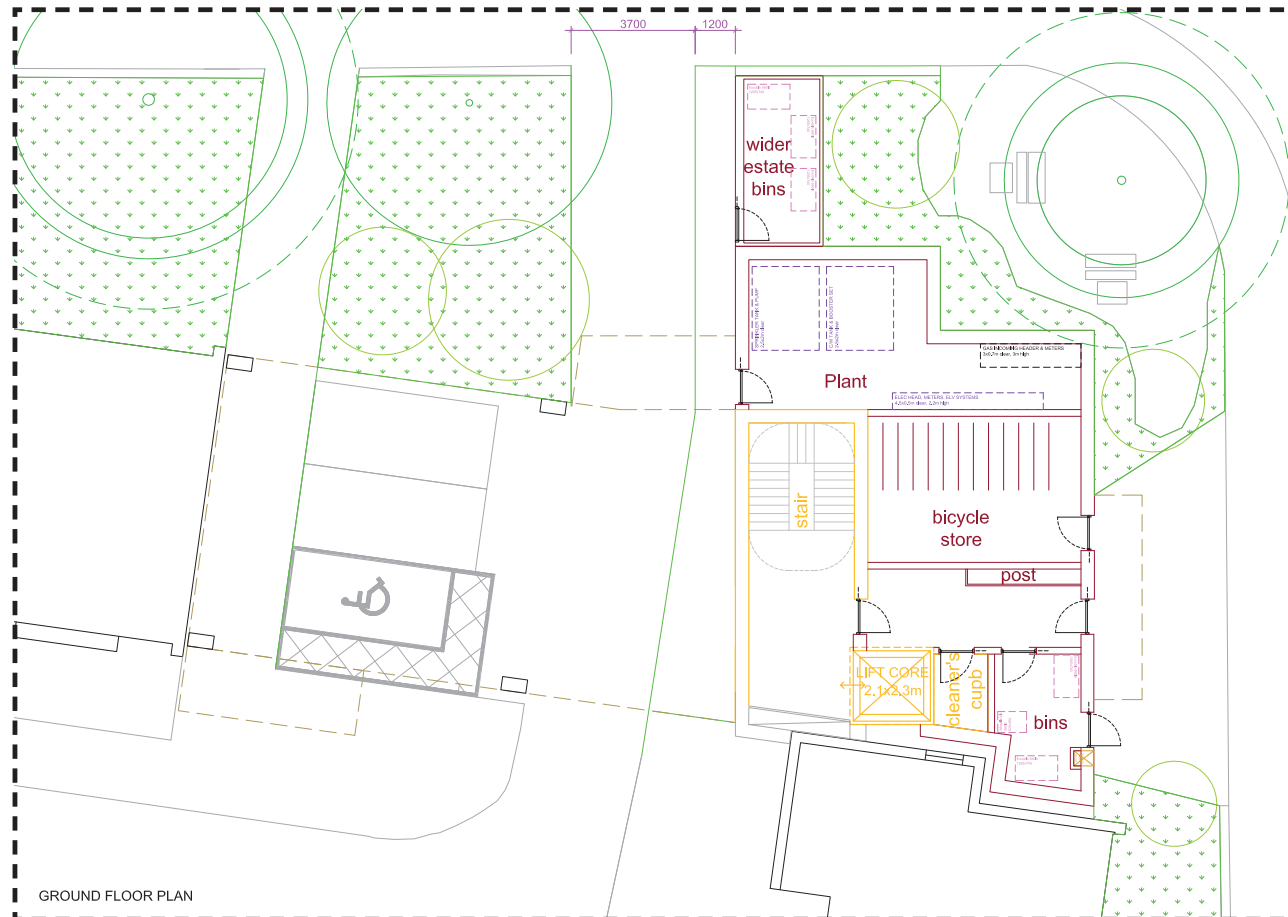

NEW LANDSCAPE PROPOSALS

- New homes main entrance from Cathay Street
- Recycling bins that were located on the corner of Paradise Street and Cathay Street relocated within separate dedicated bin enclosure (location TBC)
- Corner landscape improvements with planting, seating and new fruit trees
- Creating a new more public realm space on corner where previously used for bins
- New trees to existing shared amenity spaces
- Sufficient vehicle access for fire safety vehicles
- New dedicated pedestrian access route separate from vehicle access through shared amenity
- New pedestrian routes link with existing courtyard pavements
- 2 trees removed, 5 new trees added. Additional new trees within wider estate context being reviewed
- 3 parking spaces to be re-provided (including one disabled space). Additional relocation of parking has been tested within existing estate courtyard

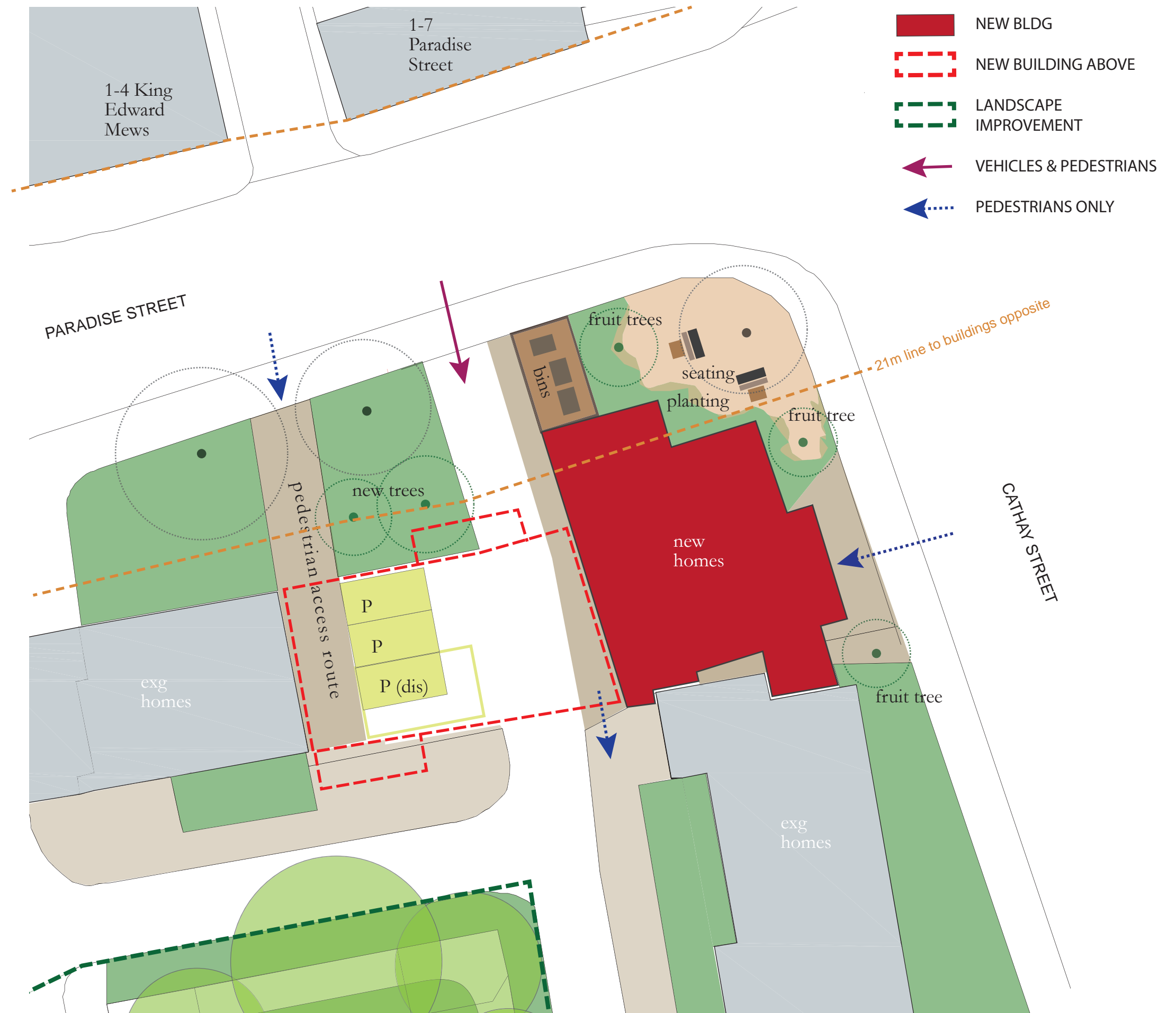

What do you think? Please let us know - contact information is at the end of this document.

NEW LANDSCAPE PROPOSALS

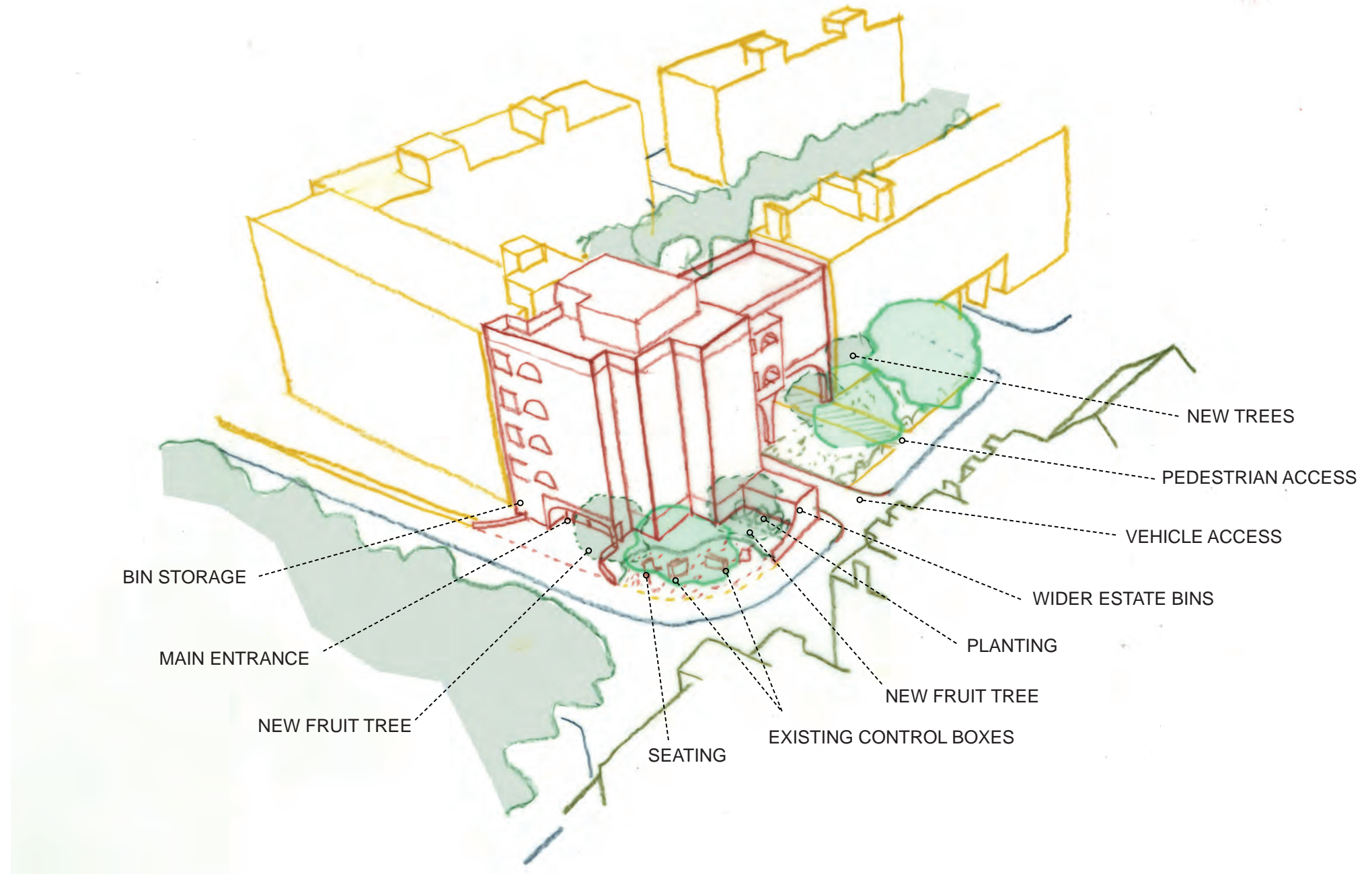

varied surface textures & paving



new trees & wildflower planting



fixed seating & shade



grove of trees with seating

What do you think? Please let us know - contact information is at the end of this document.

ESTATE LANDSCAPE

- Landscape improvements include:
 - new benches, seats & tables
 - new planting beds
 - playground improvements
 - improve openness
 - new wildlife habitats
- Strategy for car parking offset against keeping green spaces
- Vehicle access - retain full vehicle loop
- New fire vehicle access through site
- New approach to bins to resolve dumping issues

KEY

1. Improving permeability of edge, creating more openings to the garden space to increase connections & less formal
2. New planting & improvements to hard landscaping & edges
3. New varied seating, benches & tables
4. Opening up edge to improve accessibility & openness to green space
5. Relocated resident storage units & associated landscape works & improvements
6. Substation & associated landscape as existing
7. New seating, benches & tables
8. Playground improvements
9. Existing storage units retained
10. Improvements works to hard landscaping

- ←... Pedestrian access
- ← Vehicle access
- Landscape improvement areas



What do you think? Please let us know - contact information is at the end of this document.

COURTYARD LANDSCAPE IDEAS



integrated playspaces



variety of fixed benches, seats & tables

'play' for various age groups



varied but cohesive landscape



raised 'allotment' planting beds



create wildlife habitats



incidental play

What do you think? Please let us know - contact information is at the end of this document.

WIDER ESTATE BIN STORAGE

An additional residents meeting was held on 21st April 2021 to discuss proposals for the location of the wider estate recycling bin store following issues raised in the planning pre-application meeting.

In addition to these options shown here, a number of other locations were discussed including; under the existing arches, under the new arches and within the centre of the existing courtyard landscape.

It was agreed that moving the bins to within the estate courtyard would be preferable to deter fly-tipping when on street edge and help the estate management team in managing this area for the estate.

OPTION 1

- Original option
- Structure part of the architecture rather than stand alone structure
- Planting provides greenery whilst defending area against dumping
- Close proximity/ adjacent to pavement concerns

OPTION 2

- Enclosure walls curved & pulled back from pavement edge
- Structure part of the architecture rather than stand alone structure
- Curved wall opens up and softens edge to pavement
- Planting provides greenery whilst defending area against dumping
- Proximity/ adjacent to pavement concerns

OPTION 3

- Store becomes a stand alone structure
- Store within courtyard closer to existing residents
- Opens up area along Paradise Road for landscaping
- Closes off open feel of area under elevated building
- Blocks full view through under arches
- Uses up open pavement space within courtyard

OPTION 4

- Store becomes a stand alone structure
- Store within courtyard adjacent to commercial units
- Opens up area along Paradise Road for landscaping
- Uses up open pavement space within courtyard
- Limits potential options for locating commercial bins

ESTATE LANDSCAPE

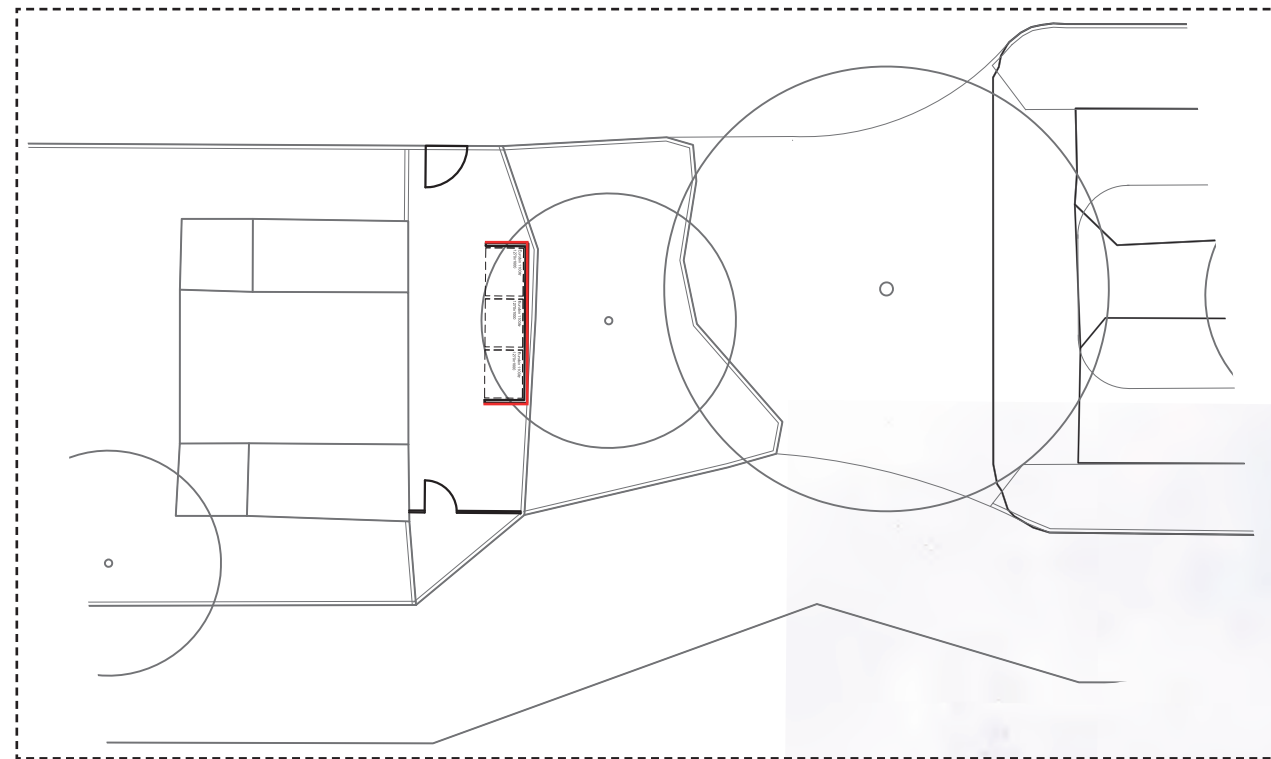

Wider estate recycling bins - new 1.4m high fence enclosure

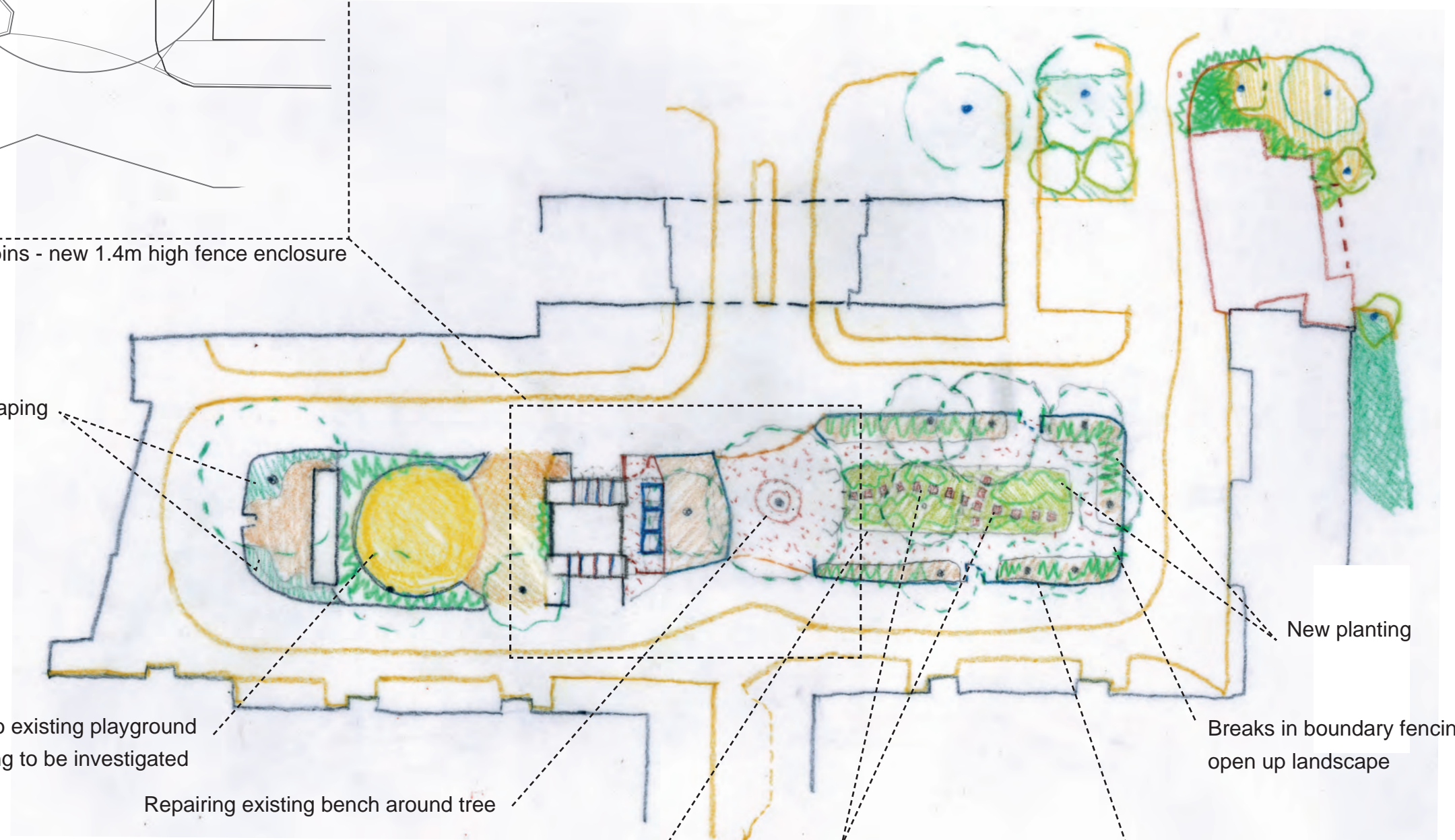

New planting to break up hard landscaping

Upgrades to existing playground
New soft play surfacing to be investigated

Repairing existing bench around tree

New surfaces to paths

Creating new informal pathways
through planing areas

New perimeter fencing to update
& unify landscape

Breaks in boundary fencing to
open up landscape

New planting

What do you think? Please let us know - contact information is at the end of this document.

ESTATE LANDSCAPE

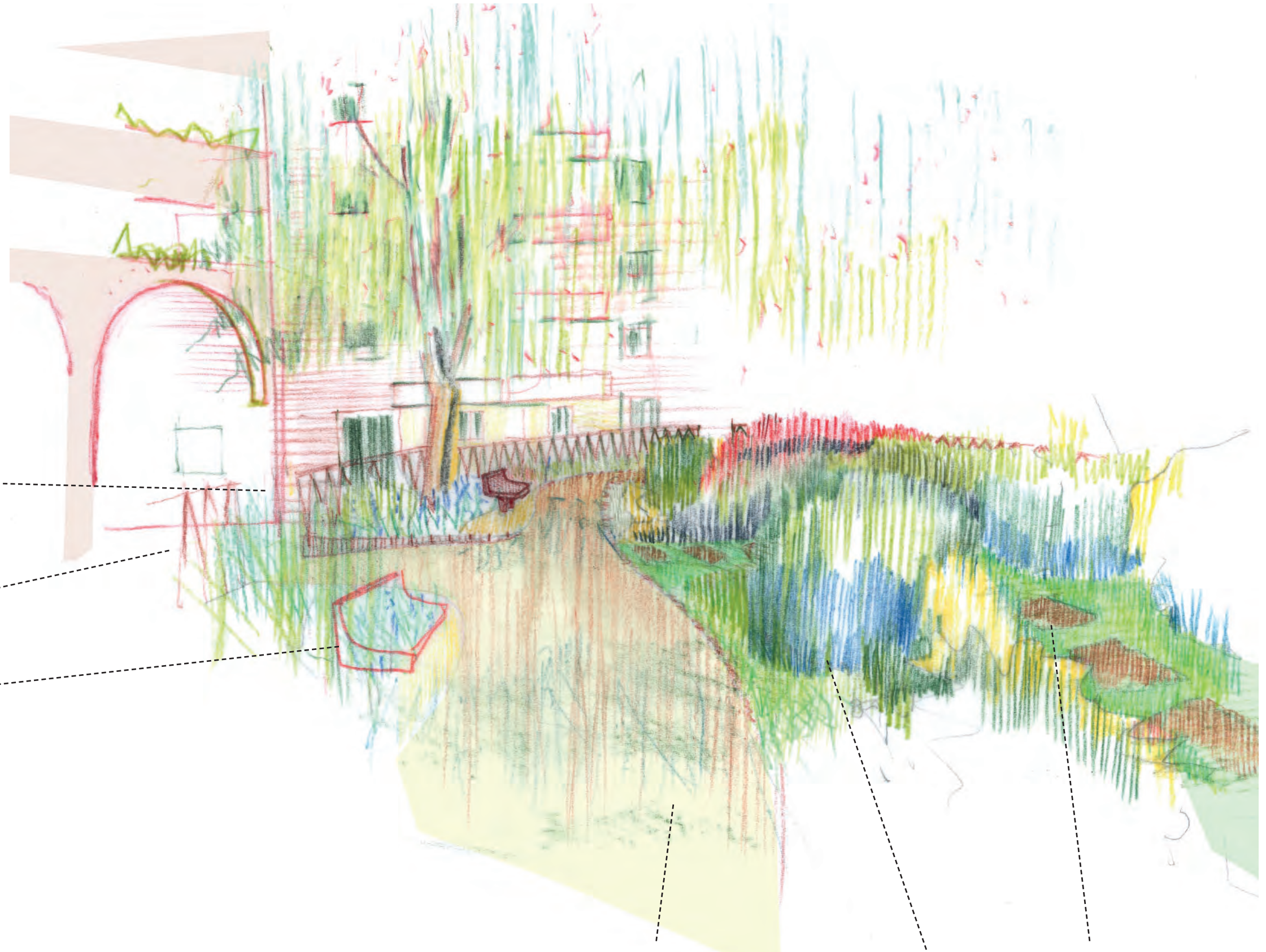

Breaks in boundary fencing to open up landscape & make more permeable

New perimeter fencing to update & unify landscape

Repairing existing benches where required

New surfaces to paths

New planting

Creating new informal pathways through planting areas

EXISTING BIKE STORAGE RELOCATION OPTIONS

OPTION A:
ON PAVEMENT EDGE UNDER THE
EXISTING ARCHES

OPTION B:
AS CURRENT PROPOSALS, ALONGSIDE
PEDESTRIAN ROUTE FROM JAMAICA
ROAD

OPTION C:
OPPOSITE SIDE OF PEDESTRIAN
ROUTE FROM JAMAICA ROAD



SKETCHES & MATERIALS DEVELOPMENT

These views show the development of indicative massing and design ideas of the proposed building and landscape from a variety of perspectives

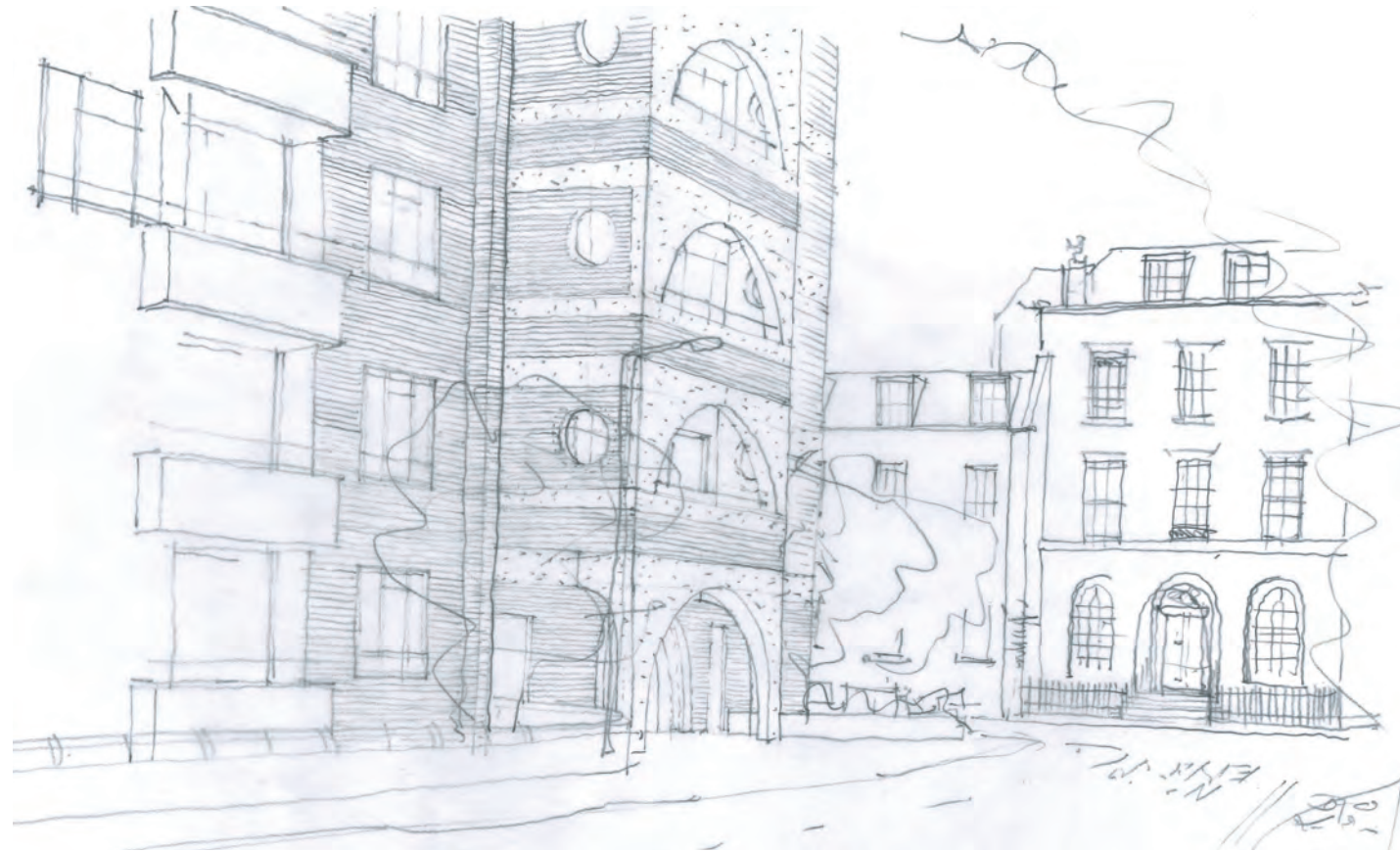

View from Cathay Street looking North

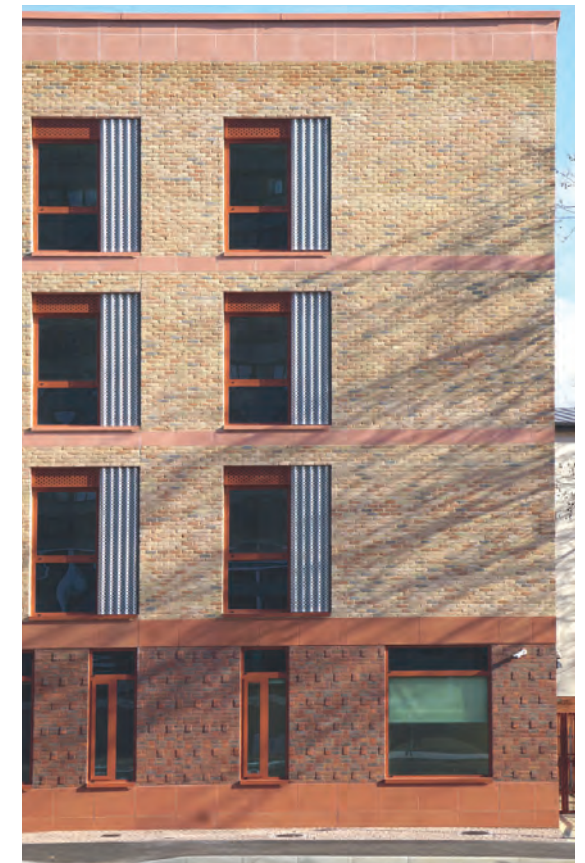

Brick & concrete banding on APF by CVA

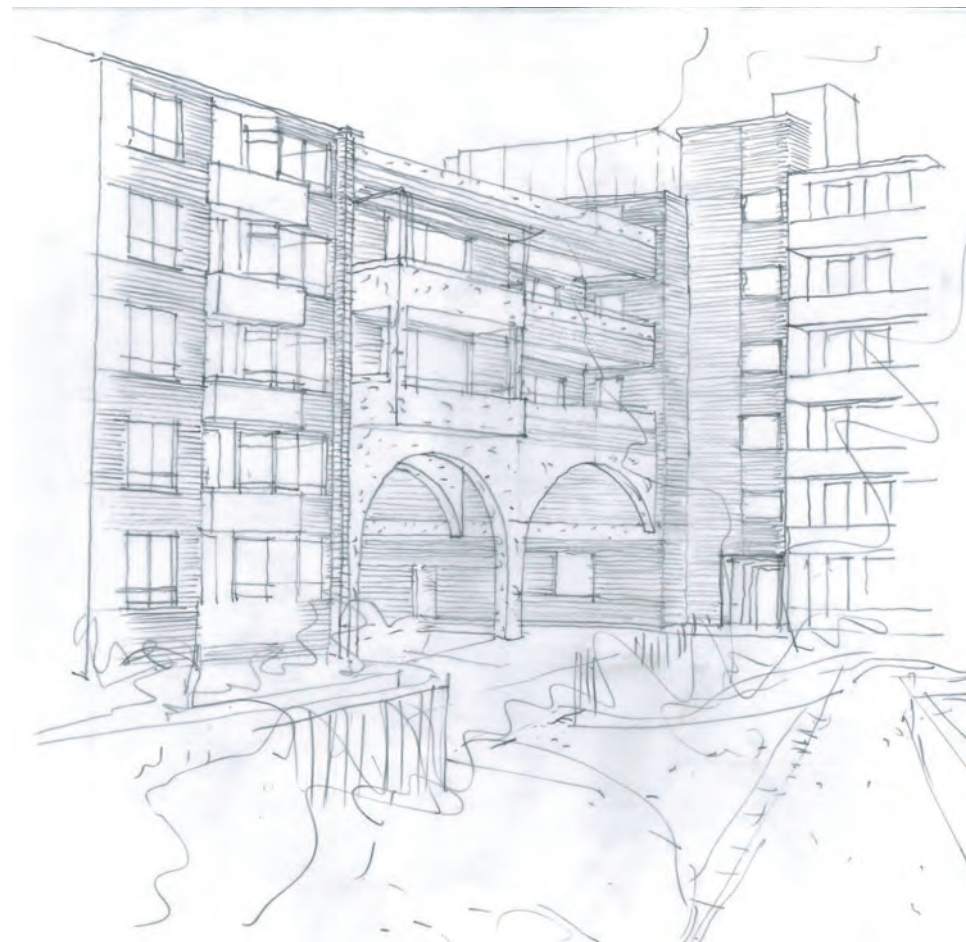

View from estate courtyard

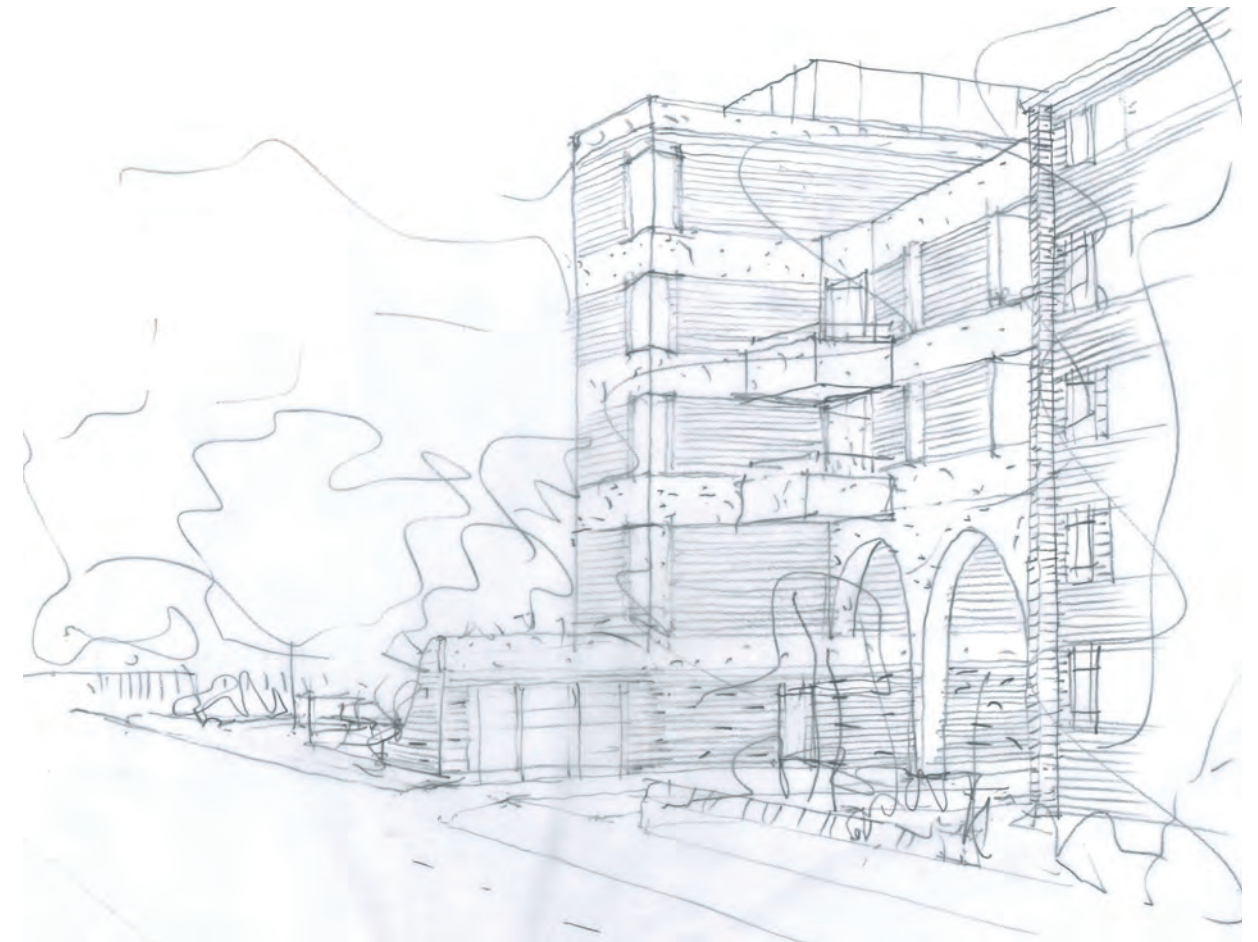

View from Paradise Street looking East

SKETCH VIEWS

These views show the development of the design from within the Estate courtyard and from the corner of Paradise Street and Cathay Street.

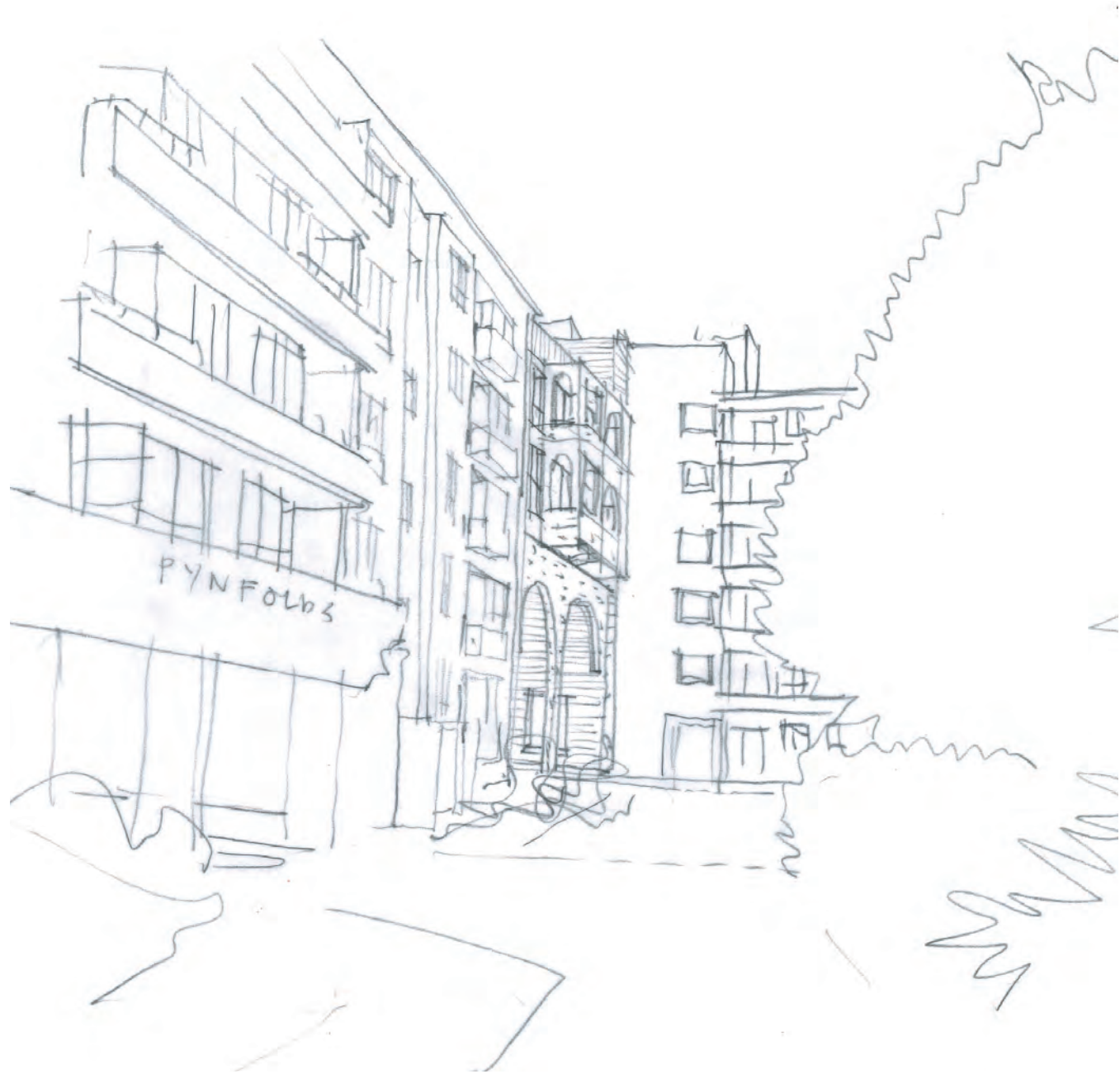

View from estate courtyard

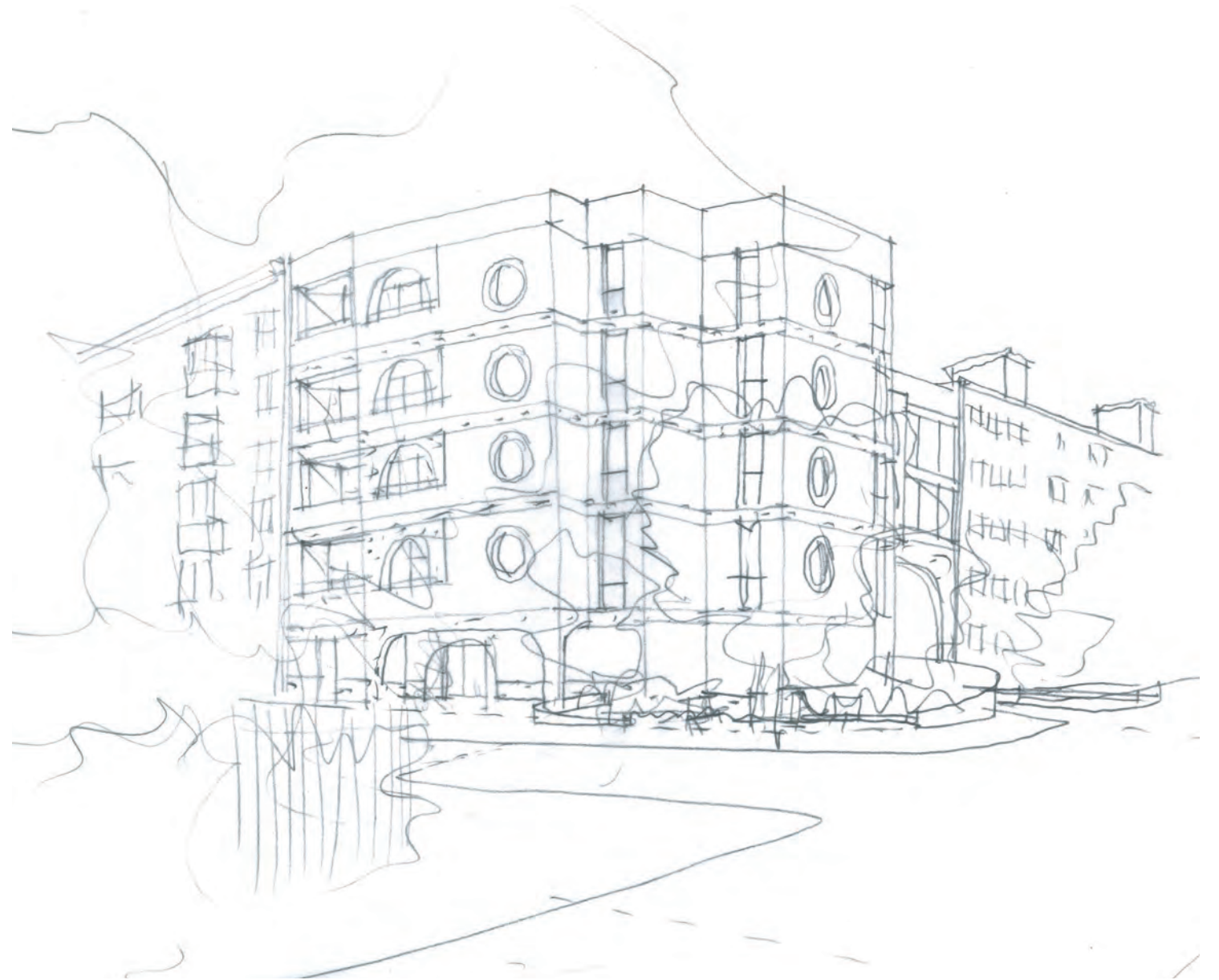

View of corner of Paradise Street & Cathay Street

ELEVATION PROPOSALS

These are the current proposals showing development ideas for design of the elevations including openings shapes, sizes and locations and material appearance.

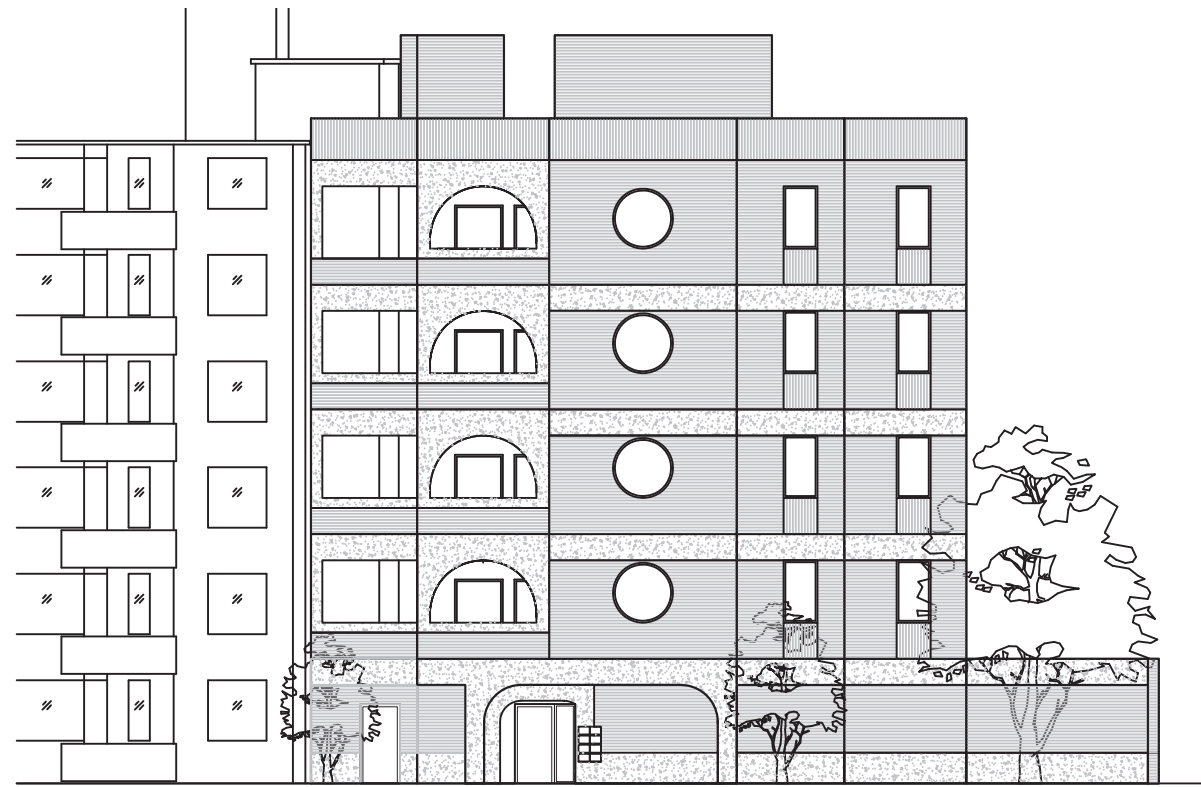

North Elevation - Paradise Street

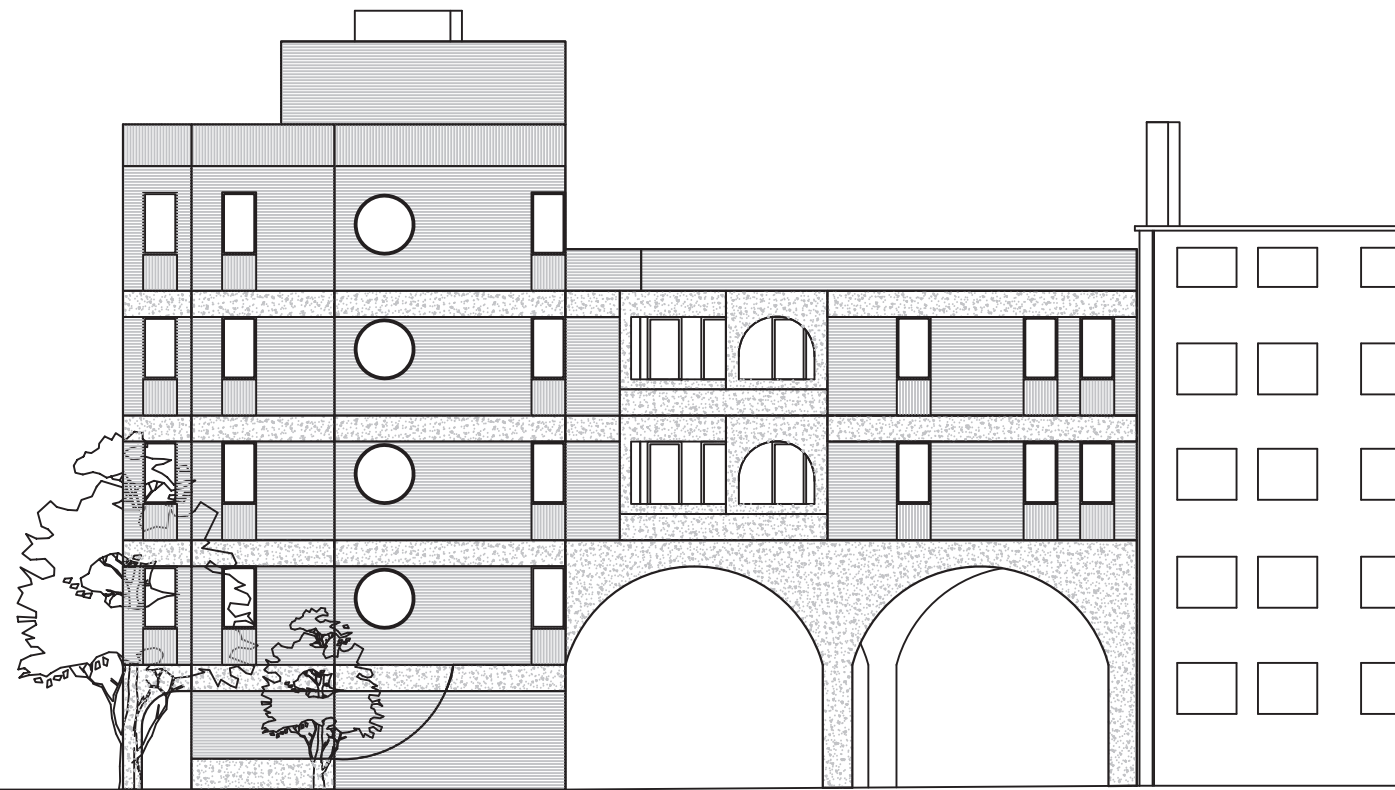

East Elevation - Cathay Street

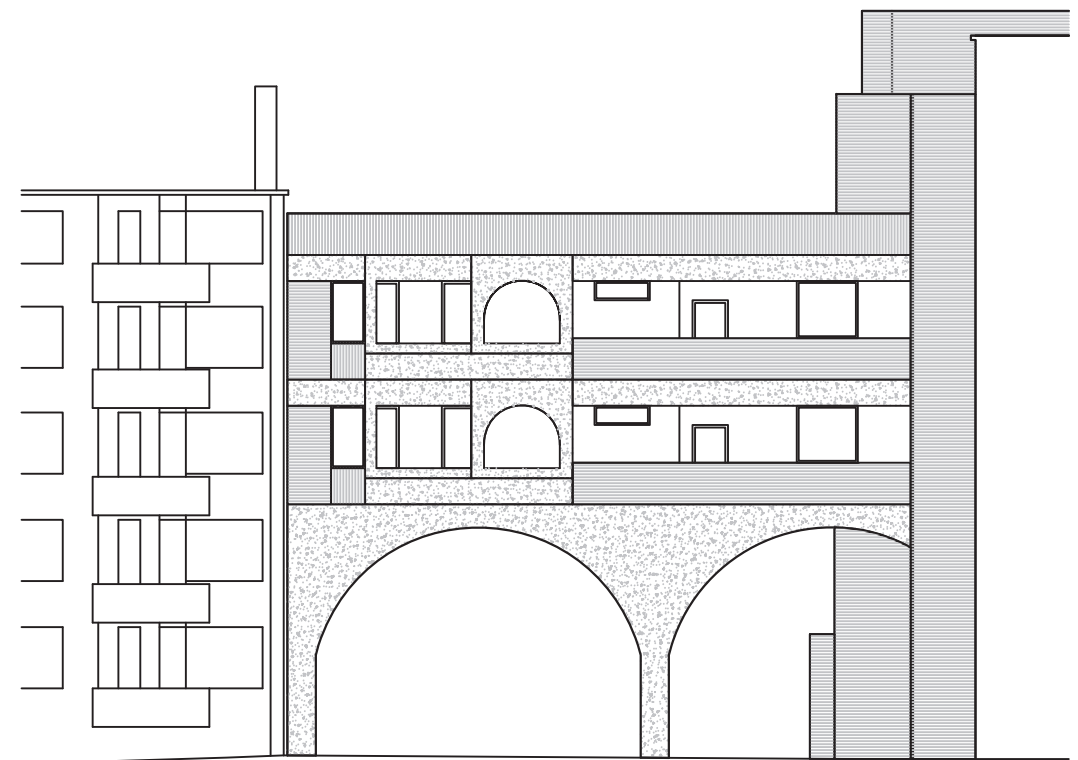

South Elevation - Pynfolds Estate Courtyard

ELEVATION PROPOSALS

These are the current proposals showing development ideas for design of the elevations showing potential material colour scheme.

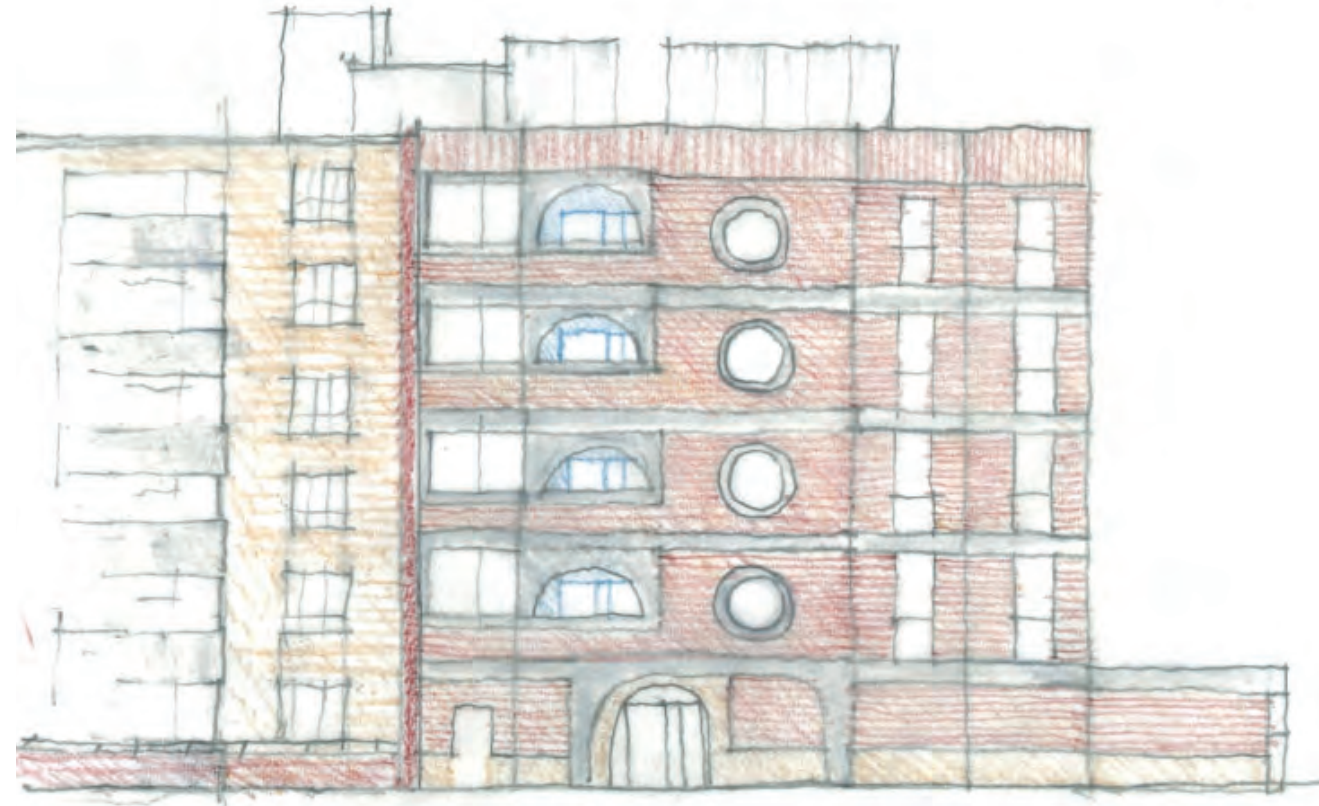

North Elevation - Paradise Street

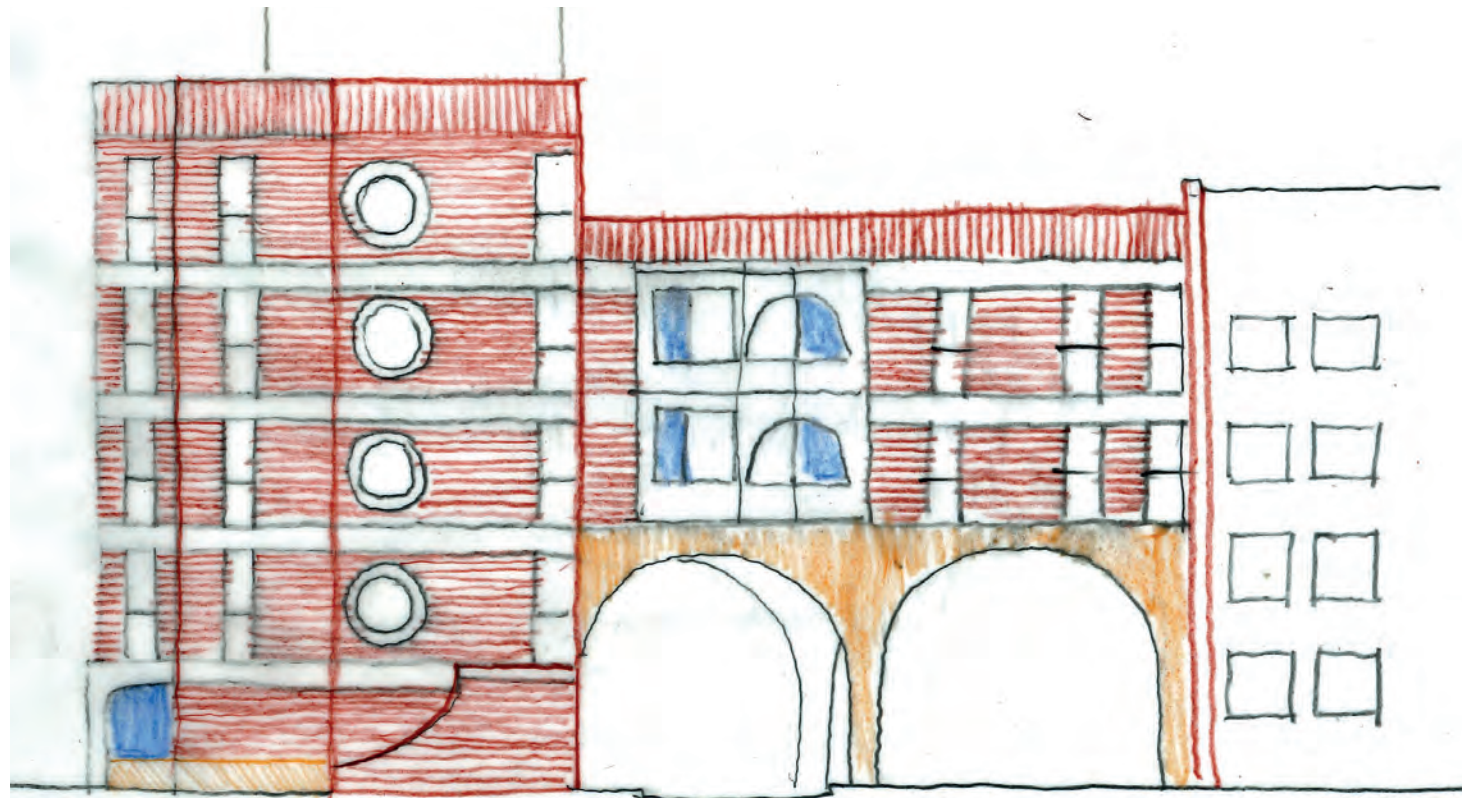

East Elevation - Cathay Street

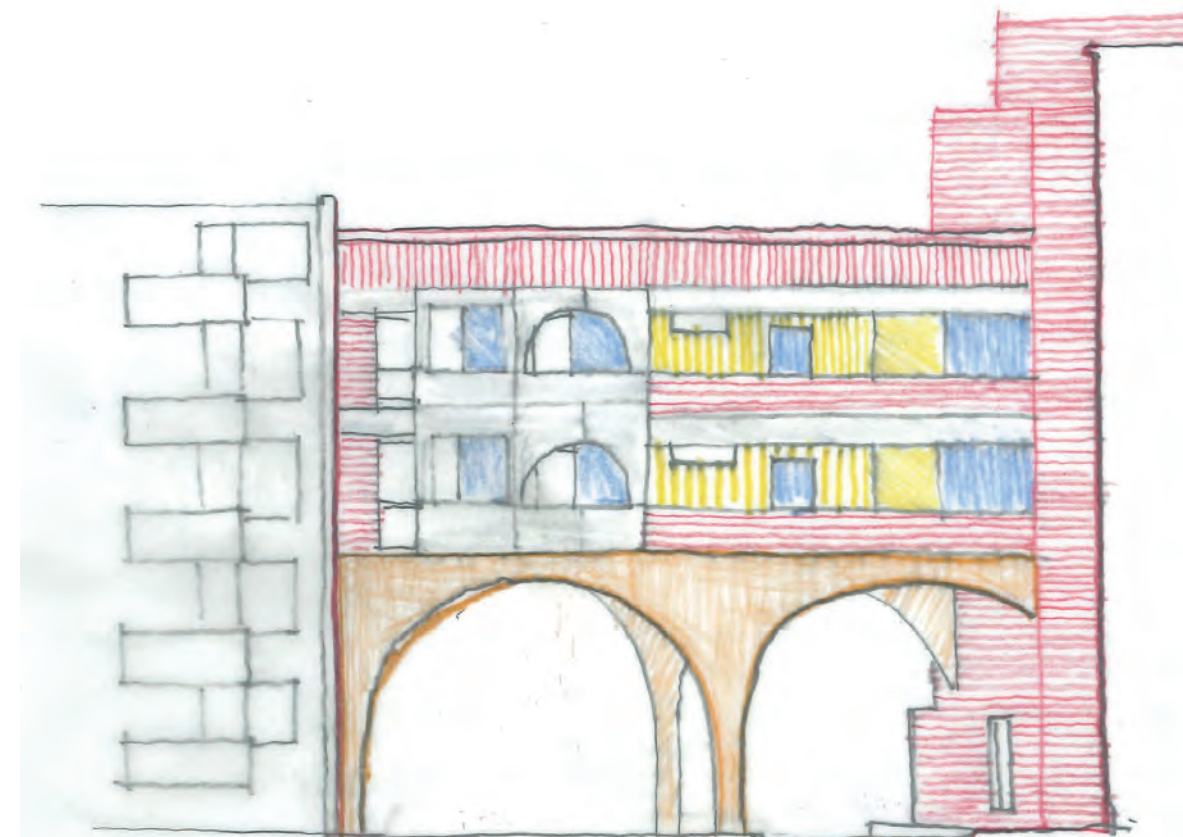

South Elevation - Pynfolds Estate Courtyard

SUNLIGHT/ DAYLIGHT ASSESSMENT

A full daylight & sunlight assessment has been carried out by an independent consultant based on the proposed massing.

Key feedback from assessment:

- *In summary, if we can assume that the side windows at 60 to 103 Pynfolds Estate (i.e. windows 1, 26, 52, 78, 104) are non habitable, then the scheme achieves an extremely high level of compliance with the BRE guide and would easily be supportable in a report.*

These windows have been confirmed as belonging to the existing stairwell and therefore non-habitable.

- *Of the rooms we have tested, only the bedroom served by window 187 falls very slightly short of the daylight distribution recommendations. Not only is this failing result extremely marginal (achieves a before/after ratio of 0.78 against the target of 0.8), but it is also a bedroom – which is considered as less important under the BRE guide.*

In response the following comments were noted by LBS planning consultant:

- *The transgressions seem to be largely below 30% loss which is usually accepted in an urban area like this one. Furthermore where daylight distribution levels have not been met, it looks like they have been met for VSC which suggests overall less impact on the perceived reduction daylight/sunlight.*
- *The one exception I can see is the Garden at 27 to 59 Pynfolds Estate, however I don't believe the planning department would form a strong objection to these preliminary outcomes.*

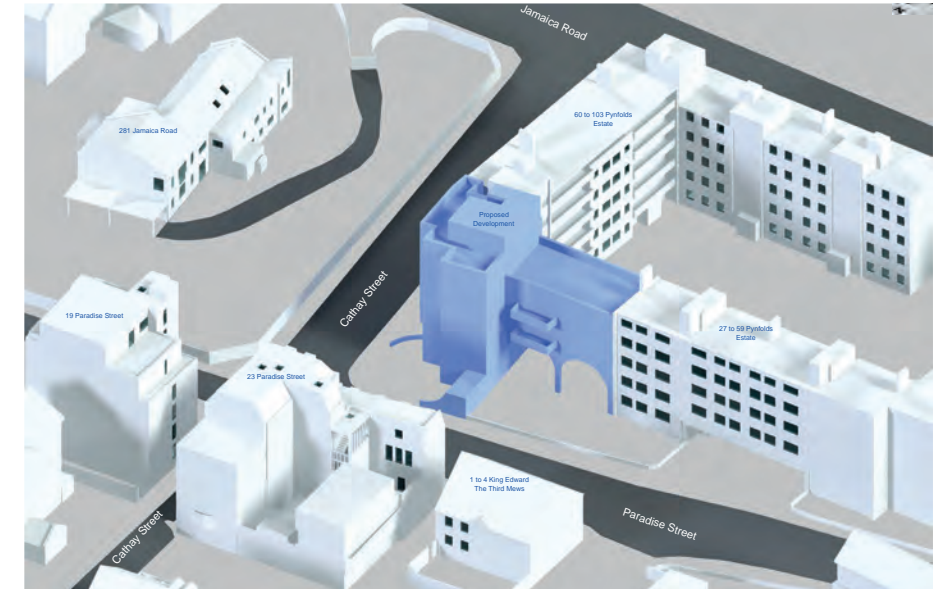
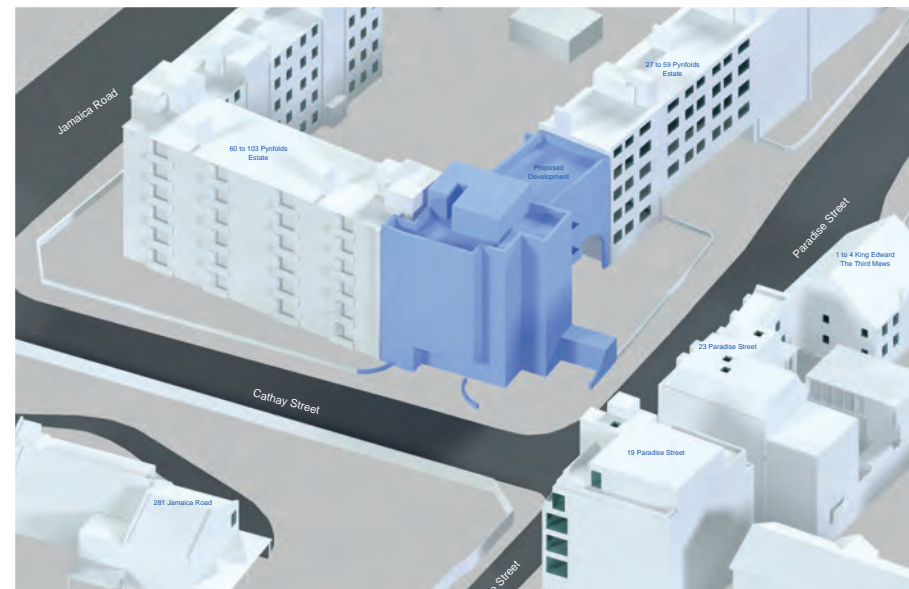
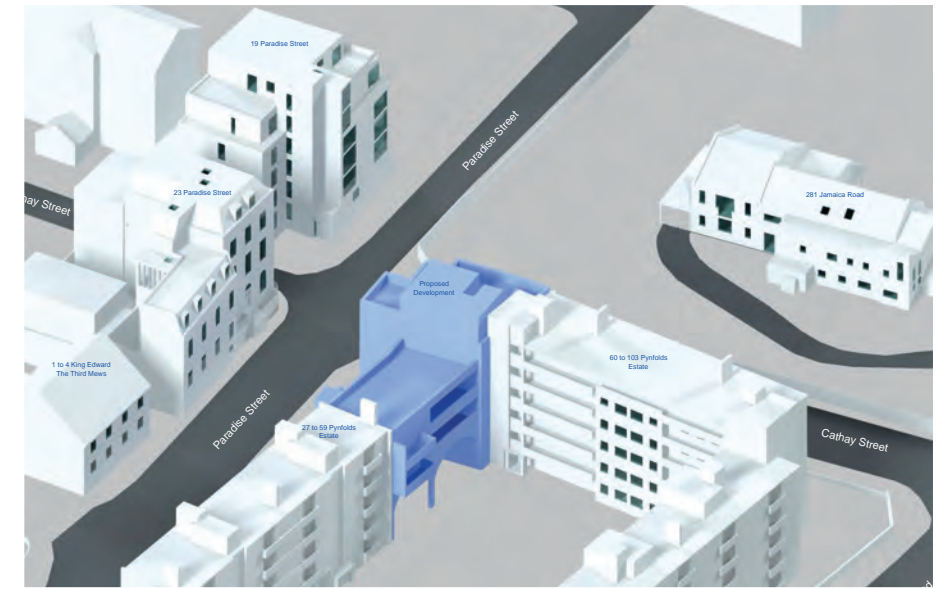

1 to 4 King Edward The Third Mews



60 to 103 Pynfolds Estate

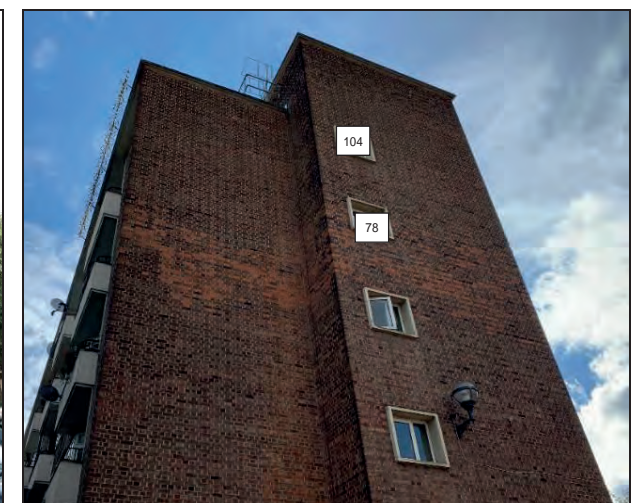

60 to 103 Pynfolds Estate

NEXT STEPS

Stage 0 Start up	Stage 1 Preparation and Brief	Stage 2 Concept Design		Stage 3 Developed Design	Stage 4/5 Tender & Construction	Stage 6 Handover
Residents Drop In	New Homes Project Group Meeting 01	New Homes Project Group Meeting 02	New Homes Project Group Meeting 03	New Homes Project Group Meeting 04	Meet the Contractor	Meet the new New Homes
Introductions	Constraints & opportunities	Design options review - strategic approaches, scale, adjacency, impact	Final concept design review - layouts, landscape, massing, material character	Respond to & review Stage 2 issues, agree actions		
Q&A	Context of existing estate	Agree priorities	Identify further work required	Review proposed developed scheme - plans, materials, functionality		
	Approaches to design	Identify further work required				
	General discussion & feedback	General discussion & feedback	General discussion & feedback	General discussion & feedback		
Project team actions Team appointment	Project team actions Site appraisal Surveys Consultation audit Risk map update Initial brief update Cost check LBS signoff	Project team actions Review & agree preferred option Strategic technical design Pre planning engagement Fire safety engagement Cost update	Project team actions Conclude Stage 2 design Risk update Stage 2 costing LBS signoff	Project team actions LBS signoff	Project team actions	Project team actions

Contact



How to get in touch

A dedicated New Homes consultation mailbox has been created for you to contact us if you have any queries; please use this email address NHDTPhase5Consultation@southwark.gov.uk

Or you can reach us by phone:

Khang Le (Project Officer) 07395 854 757

You can also access consultation information at any time by visiting the project online hub:

<https://consultations.southwark.gov.uk/housing-community-services-department-community-engagement-team/pynfolds-estate-proposed-homes/>

Covid-19 Impact

Due to current restrictions regarding Covid-19, initial Project Group meetings will be held virtually. Future meetings and consultation will be held in accordance with the latest government guidelines and the preferences of Project Group members

If you need any help or support to attend virtual meetings or would like to provide feedback in an alternative way, please let us know and we will work out alternative ways to meet your needs.